

O'REILLY®

Second
Edition

Kubernetes Up & Running

Dive into the Future of Infrastructure

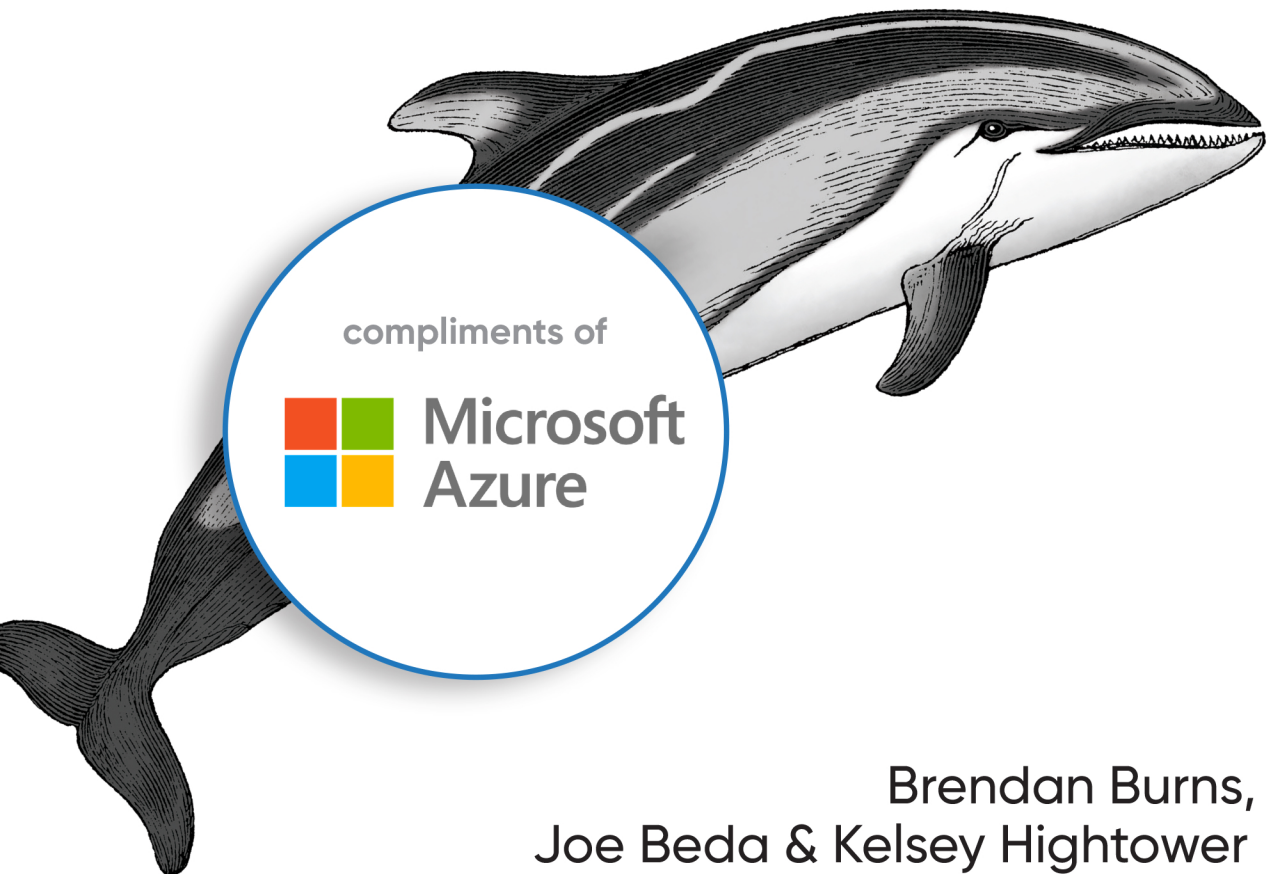

Brendan Burns,
Joe Beda & Kelsey Hightower

Kubernetes: Up & Running

Kubernetes is here to stay. In just five years, this container orchestrator has radically changed the way developers and ops personnel build, deploy, and maintain applications in the cloud. The updated edition of this popular book explains how Kubernetes can help your company achieve new levels of velocity, agility, reliability, and efficiency—whether you're new to distributed systems or have been deploying cloud native apps for some time.

Brendan Burns, Joe Beda, and Kelsey Hightower—all instrumental in conceptualizing and building Kubernetes from the start—show you how this system fits into the lifecycle of a distributed application. You'll learn how to use tools and APIs to automate scalable distributed systems for online services, machine learning applications, or even a cluster of Raspberry Pi computers.

- Create and run a simple cluster to learn how Kubernetes works
- Dive into the details of deploying an application using Kubernetes, Pods, Services, Ingress, and ReplicaSets
- Integrate storage into containerized microservices in Kubernetes
- Learn specialized objects in Kubernetes, such as DaemonSets, Jobs, ConfigMaps, and secrets
- Get practical examples of how to develop and deploy real-world applications in Kubernetes

"Written by three of the world's most highly respected authorities on cloud native systems, Kubernetes: Up & Running is the go-to book for a solid foundation in Kubernetes concepts, with examples that help you explore it for yourself."

—Liz Rice
Aqua Security

Brendan Burns, Kubernetes cofounder, is a distinguished engineer at Microsoft Azure where he leads teams focusing on DevOps, Open Source, and Microservices.

Joe Beda, Kubernetes cofounder, is a principal engineer at VMware. Joe cofounded Heptio and served as CTO until its acquisition by VMware. He helps to drive Kubernetes strategy across VMware.

Kelsey Hightower, Principal Developer Advocate for the Google Cloud Platform, has worn every hat possible throughout his career in tech, and enjoys leadership roles focused on shipping software.



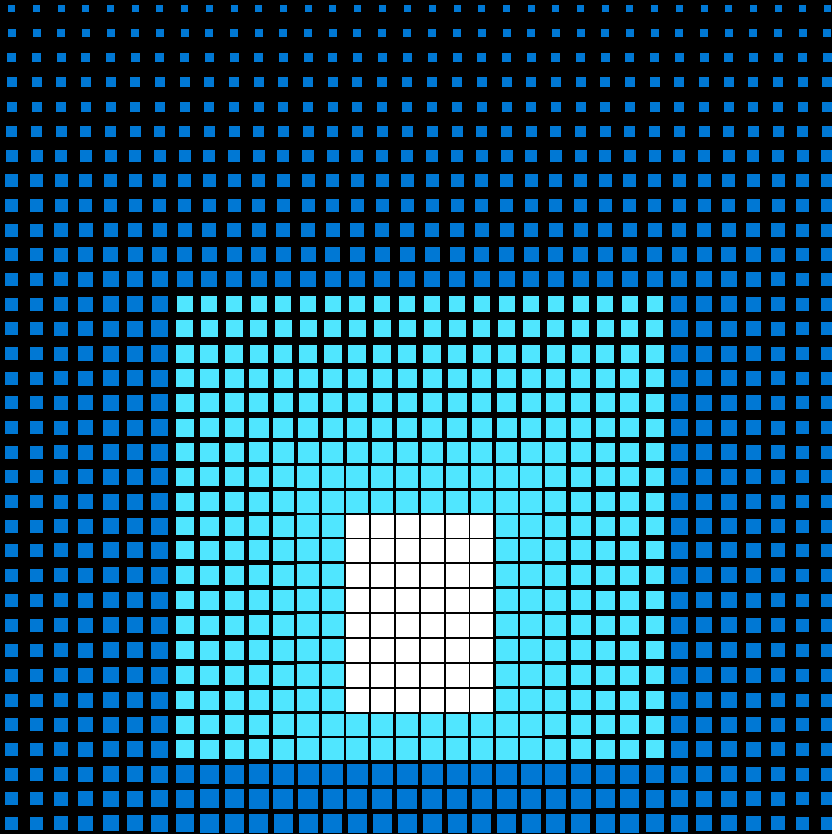

Get started

Kubernetes on Azure

Find out what you can do with a fully managed service for simplifying Kubernetes deployment, management and operations, including:

- Build microservices applications.
- Deploy a Kubernetes cluster.
- Easily monitor and manage Kubernetes.

Create a free account and get started with Kubernetes on Azure. Azure Kubernetes Service (AKS) is one of more than 25 products that are always free with your account. [Start free >](#)

Then, try these labs to master the basic and advanced tasks required to deploy a multi-container application to Kubernetes on Azure Kubernetes Service (AKS). [Try now >](#)

SECOND EDITION

Kubernetes: Up and Running

Dive into the Future of Infrastructure

Brendan Burns, Joe Beda, and Kelsey Hightower

Beijing • Boston • Farnham • Sebastopol • Tokyo

O'REILLY[®]

Kubernetes: Up and Running

by Brendan Burns, Joe Beda, and Kelsey Hightower

Copyright © 2019 Brendan Burns, Joe Beda, and Kelsey Hightower. All rights reserved.

Printed in the United States of America.

Published by O'Reilly Media, Inc., 1005 Gravenstein Highway North, Sebastopol, CA 95472.

O'Reilly books may be purchased for educational, business, or sales promotional use. Online editions are also available for most titles (<http://oreilly.com>). For more information, contact our corporate/institutional sales department: 800-998-9938 or corporate@oreilly.com.

Acquisition Editor: John Devins

Development Editor: Virginia Wilson

Production Editor: Kristen Brown

Copyeditor: Kim Cofer

Proofreader: Rachel Head

Indexer: Ellen Troutman-Zaig

Interior Designer: David Futato

Cover Designer: Karen Montgomery

Illustrator: Rebecca Demarest

September 2017: First Edition

August 2019: Second Edition

Revision History for the Second Edition

2019-07-15: First Release

See <http://oreilly.com/catalog/errata.csp?isbn=9781492046530> for release details.

The O'Reilly logo is a registered trademark of O'Reilly Media, Inc. *Kubernetes: Up and Running*, the cover image, and related trade dress are trademarks of O'Reilly Media, Inc.

The views expressed in this work are those of the authors, and do not represent the publisher's views. While the publisher and the authors have used good faith efforts to ensure that the information and instructions contained in this work are accurate, the publisher and the authors disclaim all responsibility for errors or omissions, including without limitation responsibility for damages resulting from the use of or reliance on this work. Use of the information and instructions contained in this work is at your own risk. If any code samples or other technology this work contains or describes is subject to open source licenses or the intellectual property rights of others, it is your responsibility to ensure that your use thereof complies with such licenses and/or rights.

This work is part of a collaboration between O'Reilly and Microsoft. See our [statement of editorial independence](#).

978-1-492-04653-0

[LSI]

*For Robin, Julia, Ethan, and everyone who bought cookies to pay for that Commodore
64 in my third-grade class.*

—Brendan Burns

*For my Dad, who helped me fall in love with computers by bringing home punch cards
and dot matrix banners.*

—Joe Beda

*For Klarissa and Kelis, who keep me sane. And for my Mom, who taught me a strong
work ethic and how to rise above all odds.*

—Kelsey Hightower

Table of Contents

Preface.....	xiii
1. Introduction.....	1
Velocity	2
The Value of Immutability	3
Declarative Configuration	4
Self-Healing Systems	5
Scaling Your Service and Your Teams	5
Decoupling	6
Easy Scaling for Applications and Clusters	6
Scaling Development Teams with Microservices	7
Separation of Concerns for Consistency and Scaling	8
Abstracting Your Infrastructure	9
Efficiency	10
Summary	11
2. Creating and Running Containers.....	13
Container Images	14
The Docker Image Format	15
Building Application Images with Docker	16
Dockerfiles	16
Optimizing Image Sizes	18
Image Security	19
Multistage Image Builds	20
Storing Images in a Remote Registry	22
The Docker Container Runtime	23
Running Containers with Docker	23
Exploring the kuard Application	23

Limiting Resource Usage	24
Cleanup	24
Summary	25
3. Deploying a Kubernetes Cluster	27
Installing Kubernetes on a Public Cloud Provider	28
Google Kubernetes Engine	28
Installing Kubernetes with Azure Kubernetes Service	28
Installing Kubernetes on Amazon Web Services	29
Installing Kubernetes Locally Using minikube	29
Running Kubernetes in Docker	30
Running Kubernetes on Raspberry Pi	31
The Kubernetes Client	31
Checking Cluster Status	31
Listing Kubernetes Worker Nodes	32
Cluster Components	34
Kubernetes Proxy	34
Kubernetes DNS	34
Kubernetes UI	35
Summary	36
4. Common kubectl Commands	37
Namespaces	37
Contexts	37
Viewing Kubernetes API Objects	38
Creating, Updating, and Destroying Kubernetes Objects	39
Labeling and Annotating Objects	40
Debugging Commands	40
Command Autocompletion	42
Alternative Ways of Viewing Your Cluster	42
Summary	43
5. Pods	45
Pods in Kubernetes	46
Thinking with Pods	46
The Pod Manifest	47
Creating a Pod	48
Creating a Pod Manifest	48
Running Pods	49
Listing Pods	49
Pod Details	50
Deleting a Pod	51

Accessing Your Pod	52
Using Port Forwarding	52
Getting More Info with Logs	52
Running Commands in Your Container with <code>exec</code>	53
Copying Files to and from Containers	53
Health Checks	54
Liveness Probe	54
Readiness Probe	55
Types of Health Checks	56
Resource Management	56
Resource Requests: Minimum Required Resources	56
Capping Resource Usage with Limits	58
Persisting Data with Volumes	59
Using Volumes with Pods	59
Different Ways of Using Volumes with Pods	60
Persisting Data Using Remote Disks	61
Putting It All Together	61
Summary	63
6. Labels and Annotations.....	65
Labels	65
Applying Labels	67
Modifying Labels	68
Label Selectors	68
Label Selectors in API Objects	70
Labels in the Kubernetes Architecture	71
Annotations	71
Defining Annotations	72
Cleanup	73
Summary	73
7. Service Discovery.....	75
What Is Service Discovery?	75
The Service Object	76
Service DNS	77
Readiness Checks	78
Looking Beyond the Cluster	79
Cloud Integration	81
Advanced Details	82
Endpoints	82
Manual Service Discovery	83
kube-proxy and Cluster IPs	84

Cluster IP Environment Variables	85
Connecting with Other Environments	86
Cleanup	86
Summary	86
8. HTTP Load Balancing with Ingress.....	89
Ingress Spec Versus Ingress Controllers	90
Installing Contour	91
Configuring DNS	92
Configuring a Local hosts File	92
Using Ingress	92
Simplest Usage	93
Using Hostnames	94
Using Paths	95
Cleaning Up	96
Advanced Ingress Topics and Gotchas	96
Running Multiple Ingress Controllers	97
Multiple Ingress Objects	97
Ingress and Namespaces	97
Path Rewriting	98
Serving TLS	98
Alternate Ingress Implementations	99
The Future of Ingress	100
Summary	101
9. ReplicaSets.....	103
Reconciliation Loops	104
Relating Pods and ReplicaSets	104
Adopting Existing Containers	105
Quarantining Containers	105
Designing with ReplicaSets	105
ReplicaSet Spec	106
Pod Templates	106
Labels	107
Creating a ReplicaSet	107
Inspecting a ReplicaSet	108
Finding a ReplicaSet from a Pod	108
Finding a Set of Pods for a ReplicaSet	108
Scaling ReplicaSets	109
Imperative Scaling with kubectl scale	109
Declaratively Scaling with kubectl apply	109
Autoscaling a ReplicaSet	110

Deleting ReplicaSets	111
Summary	112
10. Deployments.....	113
Your First Deployment	114
Deployment Internals	114
Creating Deployments	116
Managing Deployments	117
Updating Deployments	118
Scaling a Deployment	118
Updating a Container Image	119
Rollout History	120
Deployment Strategies	123
Recreate Strategy	123
RollingUpdate Strategy	123
Slowing Rollouts to Ensure Service Health	126
Deleting a Deployment	128
Monitoring a Deployment	128
Summary	129
11. DaemonSets.....	131
DaemonSet Scheduler	132
Creating DaemonSets	132
Limiting DaemonSets to Specific Nodes	134
Adding Labels to Nodes	135
Node Selectors	135
Updating a DaemonSet	136
Rolling Update of a DaemonSet	136
Deleting a DaemonSet	137
Summary	138
12. Jobs.....	139
The Job Object	139
Job Patterns	140
One Shot	140
Parallelism	144
Work Queues	146
CronJobs	150
Summary	151
13. ConfigMaps and Secrets.....	153
ConfigMaps	153

Creating ConfigMaps	153
Using a ConfigMap	154
Secrets	157
Creating Secrets	158
Consuming Secrets	159
Private Docker Registries	160
Naming Constraints	161
Managing ConfigMaps and Secrets	162
Listing	162
Creating	163
Updating	163
Summary	165
14. Role-Based Access Control for Kubernetes.....	167
Role-Based Access Control	168
Identity in Kubernetes	168
Understanding Roles and Role Bindings	169
Roles and Role Bindings in Kubernetes	169
Techniques for Managing RBAC	172
Testing Authorization with can-i	172
Managing RBAC in Source Control	172
Advanced Topics	172
Aggregating ClusterRoles	173
Using Groups for Bindings	173
Summary	175
15. Integrating Storage Solutions and Kubernetes.....	177
Importing External Services	178
Services Without Selectors	179
Limitations of External Services: Health Checking	181
Running Reliable Singletons	181
Running a MySQL Singleton	181
Dynamic Volume Provisioning	185
Kubernetes-Native Storage with StatefulSets	186
Properties of StatefulSets	187
Manually Replicated MongoDB with StatefulSets	187
Automating MongoDB Cluster Creation	189
Persistent Volumes and StatefulSets	192
One Final Thing: Readiness Probes	193
Summary	194

16. Extending Kubernetes.....	195
What It Means to Extend Kubernetes	195
Points of Extensibility	196
Patterns for Custom Resources	204
Just Data	204
Compilers	205
Operators	205
Getting Started	205
Summary	205
17. Deploying Real-World Applications.....	207
Jupyter	207
Parse	209
Prerequisites	209
Building the parse-server	209
Deploying the parse-server	209
Testing Parse	210
Ghost	211
Configuring Ghost	211
Redis	214
Configuring Redis	215
Creating a Redis Service	216
Deploying Redis	217
Playing with Our Redis Cluster	218
Summary	219
18. Organizing Your Application.....	221
Principles to Guide Us	221
Filesystems as the Source of Truth	222
The Role of Code Review	222
Feature Gates and Guards	223
Managing Your Application in Source Control	224
Filesystem Layout	224
Managing Periodic Versions	225
Structuring Your Application for Development, Testing, and Deployment	227
Goals	227
Progression of a Release	227
Parameterizing Your Application with Templates	229
Parameterizing with Helm and Templates	229
Filesystem Layout for Parameterization	230
Deploying Your Application Around the World	230
Architectures for Worldwide Deployment	230

Implementing Worldwide Deployment	232
Dashboards and Monitoring for Worldwide Deployments	233
Summary	233
A. Building a Raspberry Pi Kubernetes Cluster.....	235
Index.....	243

Kubernetes: A Dedication

Kubernetes would like to thank every sysadmin who has woken up at 3 a.m. to restart a process. Every developer who pushed code to production only to find that it didn't run like it did on their laptop. Every systems architect who mistakenly pointed a load test at the production service because of a leftover hostname that they hadn't updated. It was the pain, the weird hours, and the weird errors that inspired the development of Kubernetes. In a single sentence: Kubernetes intends to radically simplify the task of building, deploying, and maintaining distributed systems. It has been inspired by decades of real-world experience building reliable systems and it has been designed from the ground up to make that experience if not euphoric, at least pleasant. We hope you enjoy the book!

Who Should Read This Book

Whether you are new to distributed systems or have been deploying cloud-native systems for years, containers and Kubernetes can help you achieve new levels of velocity, agility, reliability, and efficiency. This book describes the Kubernetes cluster orchestrator and how its tools and APIs can be used to improve the development, delivery, and maintenance of distributed applications. Though no previous experience with Kubernetes is assumed, to make maximal use of the book you should be comfortable building and deploying server-based applications. Familiarity with concepts like load balancers and network storage will be useful, though not required. Likewise, experience with Linux, Linux containers, and Docker, though not essential, will help you make the most of this book.

Why We Wrote This Book

We have been involved with Kubernetes since its very beginnings. It has been truly remarkable to watch it transform from a curiosity largely used in experiments to a crucial production-grade infrastructure that powers large-scale production applications in varied fields, from machine learning to online services. As this transition occurred, it became increasingly clear that a book that captured both how to use the core concepts in Kubernetes and the motivations behind the development of those concepts would be an important contribution to the state of cloud-native application development. We hope that in reading this book, you not only learn how to build reliable, scalable applications on top of Kubernetes but also receive insight into the core challenges of distributed systems that led to its development.

Why We Updated This Book

In the few years that have passed since we wrote the first edition of this book, the Kubernetes ecosystem has blossomed and evolved. Kubernetes itself has had many releases, and many more tools and patterns for using Kubernetes have become de facto standards. In updating the book we added material on HTTP load balancing, role-based access control (RBAC), extending the Kubernetes API, how to organize your application in source control, and more. We also updated all of the existing chapters to reflect the changes and evolution in Kubernetes since the first edition. We fully expect to revise this book again in a few years (and look forward to doing so) as Kubernetes continues to evolve.

A Word on Cloud-Native Applications Today

From the first programming languages, to object-oriented programming, to the development of virtualization and cloud infrastructure, the history of computer science is a history of the development of abstractions that hide complexity and empower you to build ever more sophisticated applications. Despite this, the development of reliable, scalable applications is still dramatically more challenging than it ought to be. In recent years, containers and container orchestration APIs like Kubernetes have proven to be an important abstraction that radically simplifies the development of reliable, scalable distributed systems. Though containers and orchestrators are still in the process of entering the mainstream, they are already enabling developers to build and deploy applications with a speed, agility, and reliability that would have seemed like science fiction only a few years ago.

Navigating This Book

This book is organized as follows. [Chapter 1](#) outlines the high-level benefits of Kubernetes without diving too deeply into the details. If you are new to Kubernetes, this is a great place to start to understand why you should read the rest of the book.

[Chapter 2](#) provides a detailed introduction to containers and containerized application development. If you've never really played around with Docker before, this chapter will be a useful introduction. If you are already a Docker expert, it will likely be mostly review.

[Chapter 3](#) covers how to deploy Kubernetes. While most of this book focuses on how to *use* Kubernetes, you need to get a cluster up and running before you start using it. Although running a cluster for production is out of the scope of this book, this chapter presents a couple of easy ways to create a cluster so that you can understand how to use Kubernetes. [Chapter 4](#) covers a selection of common commands used to interact with a Kubernetes cluster.

Starting with [Chapter 5](#), we dive into the details of deploying an application using Kubernetes. We cover Pods ([Chapter 5](#)), labels and annotations ([Chapter 6](#)), services ([Chapter 7](#)), Ingress ([Chapter 8](#)), and ReplicaSets ([Chapter 9](#)). These form the core basics of what you need to deploy your service in Kubernetes. We then cover deployments ([Chapter 10](#)), which tie together the lifecycle of a complete application.

After those chapters, we cover some more specialized objects in Kubernetes: DaemonSets ([Chapter 11](#)), Jobs ([Chapter 12](#)), and ConfigMaps and secrets ([Chapter 13](#)). While these chapters are essential for many production applications, if you are just learning Kubernetes you can skip them and return to them later, after you gain more experience and expertise.

Next we cover integrating storage into Kubernetes ([Chapter 15](#)). We discuss extending Kubernetes in [Chapter 16](#). Finally, we conclude with some examples of how to develop and deploy real-world applications in Kubernetes ([Chapter 17](#)) and a discussion of how to organize your applications in source control ([Chapter 18](#)).

Online Resources

You will want to install [Docker](#). You likely will also want to familiarize yourself with the Docker documentation if you have not already done so.

Likewise, you will want to install the [kubect_l command-line tool](#). You may also want to join the [Kubernetes Slack channel](#), where you will find a large community of users who are willing to talk and answer questions at nearly any hour of the day.

Finally, as you grow more advanced, you may want to engage with the open source [Kubernetes repository on GitHub](#).

Conventions Used in This Book

The following typographical conventions are used in this book:

Italic

Indicates new terms, URLs, email addresses, filenames, and file extensions.

Constant width

Used for program listings, as well as within paragraphs to refer to program elements such as variable or function names, databases, data types, environment variables, statements, and keywords.

Constant width bold

Shows commands or other text that should be typed literally by the user.

Constant width italic

Shows text that should be replaced with user-supplied values or by values determined by context.



This icon signifies a tip, suggestion, or general note.



This icon indicates a warning or caution.

Using Code Examples

Supplemental material (code examples, exercises, etc.) is available for download at <https://github.com/kubernetes-up-and-running/examples>.

This book is here to help you get your job done. In general, if example code is offered with this book, you may use it in your programs and documentation. You do not need to contact us for permission unless you're reproducing a significant portion of the code. For example, writing a program that uses several chunks of code from this book does not require permission. Selling or distributing a CD-ROM of examples from O'Reilly books does require permission. Answering a question by citing this book and quoting example code does not require permission. Incorporating a significant amount of example code from this book into your product's documentation does require permission.

We appreciate, but do not require, attribution. An attribution usually includes the title, author, publisher, and ISBN. For example: “*Kubernetes: Up and Running*, 2nd edition, by Brendan Burns, Joe Beda, and Kelsey Hightower (O’Reilly). Copyright 2019 Brendan Burns, Joe Beda, and Kelsey Hightower, 978-1-492-04653-0.”

If you feel your use of code examples falls outside fair use or the permission given above, feel free to contact us at permissions@oreilly.com.

O’Reilly Online Learning

O’REILLY® For almost 40 years, *O’Reilly Media* has provided technology and business training, knowledge, and insight to help companies succeed.

Our unique network of experts and innovators share their knowledge and expertise through books, articles, conferences, and our online learning platform. O’Reilly’s online learning platform gives you on-demand access to live training courses, in-depth learning paths, interactive coding environments, and a vast collection of text and video from O’Reilly and 200+ other publishers. For more information, please visit <http://oreilly.com>.

How to Contact Us

Please address comments and questions concerning this book to the publisher:

O’Reilly Media, Inc.
1005 Gravenstein Highway North
Sebastopol, CA 95472
800-998-9938 (in the United States or Canada)
707-829-0515 (international or local)
707-829-0104 (fax)

We have a web page for this book, where we list errata, examples, and any additional information. You can access this page at http://bit.ly/kubernetesUR_2e.

To comment or ask technical questions about this book, send email to bookquestions@oreilly.com.

For more information about our books, courses, conferences, and news, see our website at <http://www.oreilly.com>.

Find us on Facebook: <http://facebook.com/oreilly>

Follow us on Twitter: <http://twitter.com/oreillymedia>

Watch us on YouTube: <http://www.youtube.com/oreillymedia>

Acknowledgments

We would like to acknowledge everyone who helped us develop this book. This includes our editor Virginia Wilson and all of the great folks at O'Reilly, as well as the technical reviewers who provided tremendous feedback that significantly improved the book. Finally, we would like to thank all of our first edition readers who took the time to report errata that were found and fixed in this second edition. Thank you all! We're very grateful.

Introduction

Kubernetes is an open source orchestrator for deploying containerized applications. It was originally developed by Google, inspired by a decade of experience deploying scalable, reliable systems in containers via application-oriented APIs.¹

Since its introduction in 2014, Kubernetes has grown to be one of the largest and most popular open source projects in the world. It has become the standard API for building cloud-native applications, present in nearly every public cloud. Kubernetes is a proven infrastructure for distributed systems that is suitable for cloud-native developers of all scales, from a cluster of Raspberry Pi computers to a warehouse full of the latest machines. It provides the software necessary to successfully build and deploy reliable, scalable distributed systems.

You may be wondering what we mean when we say “reliable, scalable distributed systems.” More and more services are delivered over the network via APIs. These APIs are often delivered by a *distributed system*, the various pieces that implement the API running on different machines, connected via the network and coordinating their actions via network communication. Because we rely on these APIs increasingly for all aspects of our daily lives (e.g., finding directions to the nearest hospital), these systems must be highly *reliable*. They cannot fail, even if a part of the system crashes or otherwise stops working. Likewise, they must maintain *availability* even during software rollouts or other maintenance events. Finally, because more and more of the world is coming online and using such services, they must be highly *scalable* so that they can grow their capacity to keep up with ever-increasing usage without radical redesign of the distributed system that implements the services.

¹ Brendan Burns et al., “Borg, Omega, and Kubernetes: Lessons Learned from Three Container-Management Systems over a Decade,” *ACM Queue* 14 (2016): 70–93, available at <http://bit.ly/2vIrLAS>.

Depending on when and why you have come to hold this book in your hands, you may have varying degrees of experience with containers, distributed systems, and Kubernetes. You may be planning on building your application on top of public cloud infrastructure, in private data centers, or in some hybrid environment. Regardless of what your experience is, we believe this book will enable you to make the most of your use of Kubernetes.

There are many reasons why people come to use containers and container APIs like Kubernetes, but we believe they can all be traced back to one of these benefits:

- Velocity
- Scaling (of both software and teams)
- Abstracting your infrastructure
- Efficiency

In the following sections, we describe how Kubernetes can help provide each of these features.

Velocity

Velocity is the key component in nearly all software development today. The software industry has evolved from shipping products as boxed CDs or DVDs to software that is delivered over the network via web-based services that are updated hourly. This changing landscape means that the difference between you and your competitors is often the speed with which you can develop and deploy new components and features, or the speed with which you can respond to innovations developed by others.

It is important to note, however, that velocity is not defined in terms of simply raw speed. While your users are always looking for iterative improvement, they are more interested in a highly reliable service. Once upon a time, it was OK for a service to be down for maintenance at midnight every night. But today, all users expect constant uptime, even if the software they are running is changing constantly.

Consequently, velocity is measured not in terms of the raw number of features you can ship per hour or day, but rather in terms of the number of things you can ship while maintaining a highly available service.

In this way, containers and Kubernetes can provide the tools that you need to move quickly, while staying available. The core concepts that enable this are:

- Immutability
- Declarative configuration
- Online self-healing systems

These ideas all interrelate to radically improve the speed with which you can reliably deploy software.

The Value of Immutability

Containers and Kubernetes encourage developers to build distributed systems that adhere to the principles of immutable infrastructure. With immutable infrastructure, once an artifact is created in the system it does not change via user modifications.

Traditionally, computers and software systems have been treated as *mutable* infrastructure. With mutable infrastructure, changes are applied as incremental updates to an existing system. These updates can occur all at once, or spread out across a long period of time. A system upgrade via the `apt-get update` tool is a good example of an update to a mutable system. Running `apt` sequentially downloads any updated binaries, copies them on top of older binaries, and makes incremental updates to configuration files. With a mutable system, the current state of the infrastructure is not represented as a single artifact, but rather an accumulation of incremental updates and changes over time. On many systems these incremental updates come from not just system upgrades, but operator modifications as well. Furthermore, in any system run by a large team, it is highly likely that these changes will have been performed by many different people, and in many cases will not have been recorded anywhere.

In contrast, in an immutable system, rather than a series of incremental updates and changes, an entirely new, complete image is built, where the update simply replaces the entire image with the newer image in a single operation. There are no incremental changes. As you can imagine, this is a significant shift from the more traditional world of configuration management.

To make this more concrete in the world of containers, consider two different ways to upgrade your software:

1. You can log in to a container, run a command to download your new software, kill the old server, and start the new one.
2. You can build a new container image, push it to a container registry, kill the existing container, and start a new one.

At first blush, these two approaches might seem largely indistinguishable. So what is it about the act of building a new container that improves reliability?

The key differentiation is the artifact that you create, and the record of how you created it. These records make it easy to understand exactly the differences in some new version and, if something goes wrong, to determine what has changed and how to fix it.

Additionally, building a new image rather than modifying an existing one means the old image is still around, and can quickly be used for a rollback if an error occurs. In contrast, once you copy your new binary over an existing binary, such a rollback is nearly impossible.

Immutable container images are at the core of everything that you will build in Kubernetes. It is possible to imperatively change running containers, but this is an anti-pattern to be used only in extreme cases where there are no other options (e.g., if it is the only way to temporarily repair a mission-critical production system). And even then, the changes must also be recorded through a declarative configuration update at some later time, after the fire is out.

Declarative Configuration

Immutability extends beyond containers running in your cluster to the way you describe your application to Kubernetes. Everything in Kubernetes is a *declarative configuration object* that represents the desired state of the system. It is the job of Kubernetes to ensure that the actual state of the world matches this desired state.

Much like mutable versus immutable infrastructure, declarative configuration is an alternative to *imperative* configuration, where the state of the world is defined by the execution of a series of instructions rather than a declaration of the desired state of the world. While imperative commands define actions, declarative configurations define state.

To understand these two approaches, consider the task of producing three replicas of a piece of software. With an imperative approach, the configuration would say “run A, run B, and run C.” The corresponding declarative configuration would be “replicas equals three.”

Because it describes the state of the world, declarative configuration does not have to be executed to be understood. Its impact is concretely declared. Since the effects of declarative configuration can be understood before they are executed, declarative configuration is far less error-prone. Further, the traditional tools of software development, such as source control, code review, and unit testing, can be used in declarative configuration in ways that are impossible for imperative instructions. The idea of storing declarative configuration in source control is often referred to as “infrastructure as code.”

The combination of declarative state stored in a version control system and the ability of Kubernetes to make reality match this declarative state makes rollback of a change trivially easy. It is simply restating the previous declarative state of the system. This is usually impossible with imperative systems, because although the imperative instructions describe how to get you from point A to point B, they rarely include the reverse instructions that can get you back.

Self-Healing Systems

Kubernetes is an online, self-healing system. When it receives a desired state configuration, it does not simply take a set of actions to make the current state match the desired state a single time. It *continuously* takes actions to ensure that the current state matches the desired state. This means that not only will Kubernetes initialize your system, but it will guard it against any failures or perturbations that might destabilize the system and affect reliability.

A more traditional operator repair involves a manual series of mitigation steps, or human intervention performed in response to some sort of alert. Imperative repair like this is more expensive (since it generally requires an on-call operator to be available to enact the repair). It is also generally slower, since a human must often wake up and log in to respond. Furthermore, it is less reliable because the imperative series of repair operations suffers from all of the problems of imperative management described in the previous section. Self-healing systems like Kubernetes both reduce the burden on operators and improve the overall reliability of the system by performing reliable repairs more quickly.

As a concrete example of this self-healing behavior, if you assert a desired state of three replicas to Kubernetes, it does not just create three replicas—it continuously ensures that there are exactly three replicas. If you manually create a fourth replica, Kubernetes will destroy one to bring the number back to three. If you manually destroy a replica, Kubernetes will create one to again return you to the desired state.

Online self-healing systems improve developer velocity because the time and energy you might otherwise have spent on operations and maintenance can instead be spent on developing and testing new features.

In a more advanced form of self-healing, there has been significant recent work in the *operator* paradigm for Kubernetes. With operators, more advanced logic needed to maintain, scale, and heal a specific piece of software (MySQL, for example) is encoded into an operator application that runs as a container in the cluster. The code in the operator is responsible for more targeted and advanced health detection and healing than can be achieved via Kubernetes's generic self-healing. Often this is packaged up as “operators,” which are discussed in a later section.

Scaling Your Service and Your Teams

As your product grows, it's inevitable that you will need to scale both your software and the teams that develop it. Fortunately, Kubernetes can help with both of these goals. Kubernetes achieves scalability by favoring *decoupled* architectures.

Decoupling

In a decoupled architecture, each component is separated from other components by defined APIs and service load balancers. APIs and load balancers isolate each piece of the system from the others. APIs provide a buffer between implementer and consumer, and load balancers provide a buffer between running instances of each service.

Decoupling components via load balancers makes it easy to scale the programs that make up your service, because increasing the size (and therefore the capacity) of the program can be done without adjusting or reconfiguring any of the other layers of your service.

Decoupling servers via APIs makes it easier to scale the development teams because each team can focus on a single, smaller *microservice* with a comprehensible surface area. Crisp APIs between microservices limit the amount of cross-team communication overhead required to build and deploy software. This communication overhead is often the major restricting factor when scaling teams.

Easy Scaling for Applications and Clusters

Concretely, when you need to scale your service, the immutable, declarative nature of Kubernetes makes this scaling trivial to implement. Because your containers are immutable, and the number of replicas is merely a number in a declarative config, scaling your service upward is simply a matter of changing a number in a configuration file, asserting this new declarative state to Kubernetes, and letting it take care of the rest. Alternatively, you can set up autoscaling and let Kubernetes take care of it for you.

Of course, that sort of scaling assumes that there are resources available in your cluster to consume. Sometimes you actually need to scale up the cluster itself. Again, Kubernetes makes this task easier. Because many machines in a cluster are entirely identical to other machines in that set and the applications themselves are decoupled from the details of the machine by containers, adding additional resources to the cluster is simply a matter of imaging a new machine of the same class and joining it into the cluster. This can be accomplished via a few simple commands or via a pre-baked machine image.

One of the challenges of scaling machine resources is predicting their use. If you are running on physical infrastructure, the time to obtain a new machine is measured in days or weeks. On both physical and cloud infrastructure, predicting future costs is difficult because it is hard to predict the growth and scaling needs of specific applications.

Kubernetes can simplify forecasting future compute costs. To understand why this is true, consider scaling up three teams, A, B, and C. Historically you have seen that

each team's growth is highly variable and thus hard to predict. If you are provisioning individual machines for each service, you have no choice but to forecast based on the maximum expected growth for each service, since machines dedicated to one team cannot be used for another team. If instead you use Kubernetes to decouple the teams from the specific machines they are using, you can forecast growth based on the aggregate growth of all three services. Combining three variable growth rates into a single growth rate reduces statistical noise and produces a more reliable forecast of expected growth. Furthermore, decoupling the teams from specific machines means that teams can share fractional parts of one another's machines, reducing even further the overheads associated with forecasting growth of computing resources.

Scaling Development Teams with Microservices

As noted in a variety of research, the ideal team size is the “two-pizza team,” or roughly six to eight people. This group size often results in good knowledge sharing, fast decision making, and a common sense of purpose. Larger teams tend to suffer from issues of hierarchy, poor visibility, and infighting, which hinder agility and success.

However, many projects require significantly more resources to be successful and achieve their goals. Consequently, there is a tension between the ideal team size for agility and the necessary team size for the product's end goals.

The common solution to this tension has been the development of decoupled, service-oriented teams that each build a single microservice. Each small team is responsible for the design and delivery of a service that is consumed by other small teams. The aggregation of all of these services ultimately provides the implementation of the overall product's surface area.

Kubernetes provides numerous abstractions and APIs that make it easier to build these decoupled microservice architectures:

- *Pods*, or groups of containers, can group together container images developed by different teams into a single deployable unit.
- Kubernetes *services* provide load balancing, naming, and discovery to isolate one microservice from another.
- *Namespaces* provide isolation and access control, so that each microservice can control the degree to which other services interact with it.
- *Ingress* objects provide an easy-to-use frontend that can combine multiple microservices into a single externalized API surface area.

Finally, decoupling the application container image and machine means that different microservices can colocate on the same machine without interfering with one another, reducing the overhead and cost of microservice architectures. The health-

checking and rollout features of Kubernetes guarantee a consistent approach to application rollout and reliability that ensures that a proliferation of microservice teams does not also result in a proliferation of different approaches to service production lifecycle and operations.

Separation of Concerns for Consistency and Scaling

In addition to the consistency that Kubernetes brings to operations, the decoupling and separation of concerns produced by the Kubernetes stack lead to significantly greater consistency for the lower levels of your infrastructure. This enables you to scale infrastructure operations to manage many machines with a single small, focused team. We have talked at length about the decoupling of application container and machine/operating system (OS), but an important aspect of this decoupling is that the container orchestration API becomes a crisp contract that separates the responsibilities of the application operator from the cluster orchestration operator. We call this the “not my monkey, not my circus” line. The application developer relies on the service-level agreement (SLA) delivered by the container orchestration API, without worrying about the details of how this SLA is achieved. Likewise, the container orchestration API reliability engineer focuses on delivering the orchestration API’s SLA without worrying about the applications that are running on top of it.

This decoupling of concerns means that a small team running a Kubernetes cluster can be responsible for supporting hundreds or even thousands of teams running applications within that cluster (Figure 1-1). Likewise, a small team can be responsible for dozens (or more) of clusters running around the world. It’s important to note that the same decoupling of containers and OS enables the OS reliability engineers to focus on the SLA of the individual machine’s OS. This becomes another line of separate responsibility, with the Kubernetes operators relying on the OS SLA, and the OS operators worrying solely about delivering that SLA. Again, this enables you to scale a small team of OS experts to a fleet of thousands of machines.

Of course, devoting even a small team to managing an OS is beyond the scale of many organizations. In these environments, a managed Kubernetes-as-a-Service (KaaS) provided by a public cloud provider is a great option. As Kubernetes has become increasingly ubiquitous, KaaS has become increasingly available as well, to the point where it is now offered on nearly every public cloud. Of course, using a KaaS has some limitations, since the operator makes decisions for you about how the Kubernetes clusters are built and configured. For example, many KaaS platforms disable alpha features because they can destabilize the managed cluster.

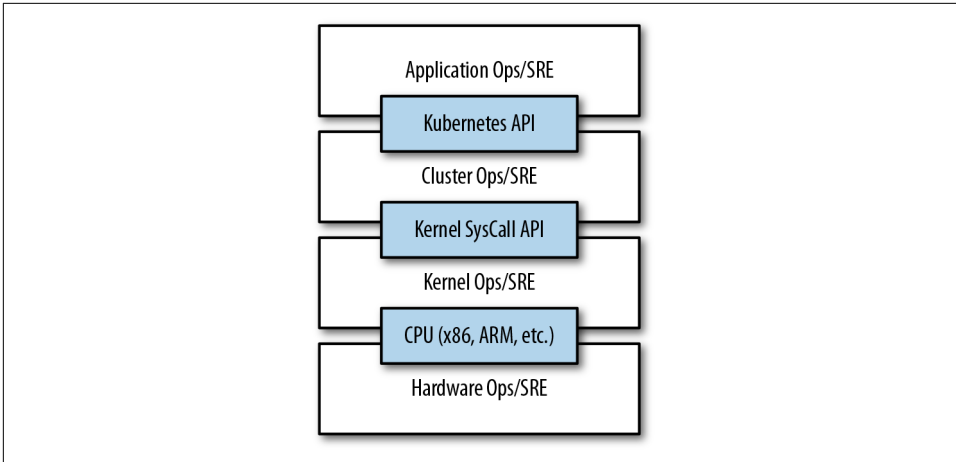

Figure 1-1. An illustration of how different operations teams are decoupled using APIs

In addition to a fully managed Kubernetes service, there is a thriving ecosystem of companies and projects that help to install and manage Kubernetes. There is a full spectrum of solutions between doing it “the hard way” and a fully managed service.

Consequently, the decision of whether to use KaaS or manage it yourself (or something in between) is one each user needs to make based on the skills and demands of their situation. Often for small organizations, KaaS provides an easy-to-use solution that enables them to focus their time and energy on building the software to support their work rather than managing a cluster. For a larger organization that can afford a dedicated team for managing its Kubernetes cluster, it may make sense to manage it yourself since it enables greater flexibility in terms of cluster capabilities and operations.

Abstracting Your Infrastructure

The goal of the public cloud is to provide easy-to-use, self-service infrastructure for developers to consume. However, too often cloud APIs are oriented around mirroring the infrastructure that IT expects, not the concepts (e.g., “virtual machines” instead of “applications”) that developers want to consume. Additionally, in many cases the cloud comes with particular details in implementation or services that are specific to the cloud provider. Consuming these APIs directly makes it difficult to run your application in multiple environments, or spread between cloud and physical environments.

The move to application-oriented container APIs like Kubernetes has two concrete benefits. First, as we described previously, it separates developers from specific machines. This makes the machine-oriented IT role easier, since machines can simply

be added in aggregate to scale the cluster, and in the context of the cloud it also enables a high degree of portability since developers are consuming a higher-level API that is implemented in terms of the specific cloud infrastructure APIs.

When your developers build their applications in terms of container images and deploy them in terms of portable Kubernetes APIs, transferring your application between environments, or even running in hybrid environments, is simply a matter of sending the declarative config to a new cluster. Kubernetes has a number of plug-ins that can abstract you from a particular cloud. For example, Kubernetes services know how to create load balancers on all major public clouds as well as several different private and physical infrastructures. Likewise, Kubernetes `PersistentVolumes` and `PersistentVolumeClaims` can be used to abstract your applications away from specific storage implementations. Of course, to achieve this portability you need to avoid cloud-managed services (e.g., Amazon's DynamoDB, Azure's CosmosDB, or Google's Cloud Spanner), which means that you will be forced to deploy and manage open source storage solutions like Cassandra, MySQL, or MongoDB.

Putting it all together, building on top of Kubernetes's application-oriented abstractions ensures that the effort you put into building, deploying, and managing your application is truly portable across a wide variety of environments.

Efficiency

In addition to the developer and IT management benefits that containers and Kubernetes provide, there is also a concrete economic benefit to the abstraction. Because developers no longer think in terms of machines, their applications can be colocated on the same machines without impacting the applications themselves. This means that tasks from multiple users can be packed tightly onto fewer machines.

Efficiency can be measured by the ratio of the useful work performed by a machine or process to the total amount of energy spent doing so. When it comes to deploying and managing applications, many of the available tools and processes (e.g., bash scripts, `apt` updates, or imperative configuration management) are somewhat inefficient. When discussing efficiency it's often helpful to think of both the cost of running a server and the human cost required to manage it.

Running a server incurs a cost based on power usage, cooling requirements, data-center space, and raw compute power. Once a server is racked and powered on (or clicked and spun up), the meter literally starts running. Any idle CPU time is money wasted. Thus, it becomes part of the system administrator's responsibilities to keep utilization at acceptable levels, which requires ongoing management. This is where containers and the Kubernetes workflow come in. Kubernetes provides tools that automate the distribution of applications across a cluster of machines, ensuring higher levels of utilization than are possible with traditional tooling.

A further increase in efficiency comes from the fact that a developer's test environment can be quickly and cheaply created as a set of containers running in a personal view of a shared Kubernetes cluster (using a feature called namespaces). In the past, turning up a test cluster for a developer might have meant turning up three machines. With Kubernetes it is simple to have all developers share a single test cluster, aggregating their usage onto a much smaller set of machines. Reducing the overall number of machines used in turn drives up the efficiency of each system: since more of the resources (CPU, RAM, etc.) on each individual machine are used, the overall cost of each container becomes much lower.

Reducing the cost of development instances in your stack enables development practices that might previously have been cost-prohibitive. For example, with your application deployed via Kubernetes it becomes conceivable to deploy and test every single commit contributed by every developer throughout your entire stack.

When the cost of each deployment is measured in terms of a small number of containers, rather than multiple complete virtual machines (VMs), the cost you incur for such testing is dramatically lower. Returning to the original value of Kubernetes, this increased testing also increases velocity, since you have strong signals as to the reliability of your code as well as the granularity of detail required to quickly identify where a problem may have been introduced.

Summary

Kubernetes was built to radically change the way that applications are built and deployed in the cloud. Fundamentally, it was designed to give developers more velocity, efficiency, and agility. We hope the preceding sections have given you an idea of why you should deploy your applications using Kubernetes. Now that you are convinced of that, the following chapters will teach you *how* to deploy your application.

Creating and Running Containers

Kubernetes is a platform for creating, deploying, and managing distributed applications. These applications come in many different shapes and sizes, but ultimately, they are all comprised of one or more programs that run on individual machines. These programs accept input, manipulate data, and then return the results. Before we can even consider building a distributed system, we must first consider how to build the *application container images* that contain these programs and make up the pieces of our distributed system.

Application programs are typically comprised of a language runtime, libraries, and your source code. In many cases, your application relies on external shared libraries such as `libc` and `libssl`. These external libraries are generally shipped as shared components in the OS that you have installed on a particular machine.

This dependency on shared libraries causes problems when an application developed on a programmer's laptop has a dependency on a shared library that isn't available when the program is rolled out to the production OS. Even when the development and production environments share the exact same version of the OS, problems can occur when developers forget to include dependent asset files inside a package that they deploy to production.

The traditional methods of running multiple programs on a single machine require that all of these programs share the same versions of shared libraries on the system. If the different programs are developed by different teams or organizations, these shared dependencies add needless complexity and coupling between these teams.

A program can only execute successfully if it can be reliably deployed onto the machine where it should run. Too often the state of the art for deployment involves running imperative scripts, which inevitably have twisty and byzantine failure cases.

This makes the task of rolling out a new version of all or parts of a distributed system a labor-intensive and difficult task.

In [Chapter 1](#), we argued strongly for the value of immutable images and infrastructure. This immutability is exactly what the container image provides. As we will see, it easily solves all the problems of dependency management and encapsulation just described.

When working with applications it's often helpful to package them in a way that makes it easy to share them with others. Docker, the default container runtime engine, makes it easy to package an executable and push it to a remote registry where it can later be pulled by others. At the time of writing, container registries are available in all of the major public clouds, and services to build images in the cloud are also available in many of them. You can also run your own registry using open source or commercial systems. These registries make it easy for users to manage and deploy private images, while image-builder services provide easy integration with continuous delivery systems.

For this chapter, and the remainder of the book, we are going to work with a simple example application that we built to help show this workflow in action. You can find the application [on GitHub](#).

Container images bundle a program and its dependencies into a single artifact under a root filesystem. The most popular container image format is the Docker image format, which has been standardized by the Open Container Initiative to the OCI image format. Kubernetes supports both Docker- and OCI-compatible images via Docker and other runtimes. Docker images also include additional metadata used by a container runtime to start a running application instance based on the contents of the container image.

This chapter covers the following topics:

- How to package an application using the Docker image format
- How to start an application using the Docker container runtime

Container Images

For nearly everyone, their first interaction with any container technology is with a container image. A *container image* is a binary package that encapsulates all of the files necessary to run a program inside of an OS container. Depending on how you first experiment with containers, you will either build a container image from your local filesystem or download a preexisting image from a *container registry*. In either case, once the container image is present on your computer, you can run that image to produce a running application inside an OS container.

The Docker Image Format

The most popular and widespread container image format is the Docker image format, which was developed by the Docker open source project for packaging, distributing, and running containers using the `docker` command. Subsequently, work has begun by Docker, Inc., and others to standardize the container image format via the Open Container Initiative (OCI) project. While the OCI standard achieved a 1.0 release milestone in mid-2017, adoption of these standards is proceeding slowly. The Docker image format continues to be the de facto standard, and is made up of a series of filesystem layers. Each layer adds, removes, or modifies files from the preceding layer in the filesystem. This is an example of an *overlay* filesystem. The overlay system is used both when packaging up the image and when the image is actually being used. During runtime, there are a variety of different concrete implementations of such filesystems, including `aufs`, `overlay`, and `overlay2`.

Container Layering

The phrases “Docker image format” and “container images” may be a bit confusing. The image isn’t a single file but rather a specification for a manifest file that points to other files. The manifest and associated files are often treated by users as a unit. The level of indirection allows for more efficient storage and transmittal. Associated with this format is an API for uploading and downloading images to an image registry.

Container images are constructed with a series of filesystem layers, where each layer inherits and modifies the layers that came before it. To help explain this in detail, let’s build some containers. Note that for correctness the ordering of the layers should be bottom up, but for ease of understanding we take the opposite approach:

- ┆ container A: a base operating system only, such as Debian
 - ┆ container B: build upon #A, by adding Ruby v2.1.10
 - ┆ container C: build upon #A, by adding Golang v1.6

At this point we have three containers: A, B, and C. B and C are *forked* from A and share nothing besides the base container’s files. Taking it further, we can build on top of B by adding Rails (version 4.2.6). We may also want to support a legacy application that requires an older version of Rails (e.g., version 3.2.x). We can build a container image to support that application based on B also, planning to someday migrate the app to version 4:

- ┆ (continuing from above)
 - ┆ container B: build upon #A, by adding Ruby v2.1.10
 - ┆ container D: build upon #B, by adding Rails v4.2.6
 - ┆ container E: build upon #B, by adding Rails v3.2.x

Conceptually, each container image layer builds upon a previous one. Each parent reference is a pointer. While the example here is a simple set of containers, other real-world containers can be part of a larger extensive directed acyclic graph.

Container images are typically combined with a container configuration file, which provides instructions on how to set up the container environment and execute an application entry point. The container configuration often includes information on how to set up networking, namespace isolation, resource constraints (cgroups), and what `syscall` restrictions should be placed on a running container instance. The container root filesystem and configuration file are typically bundled using the Docker image format.

Containers fall into two main categories:

- System containers
- Application containers

System containers seek to mimic virtual machines and often run a full boot process. They often include a set of system services typically found in a VM, such as `ssh`, `cron`, and `syslog`. When Docker was new, these types of containers were much more common. Over time, they have come to be seen as poor practice and application containers have gained favor.

Application containers differ from system containers in that they commonly run a single program. While running a single program per container might seem like an unnecessary constraint, it provides the perfect level of granularity for composing scalable applications and is a design philosophy that is leveraged heavily by Pods. We will examine how Pods work in detail in [Chapter 5](#).

Building Application Images with Docker

In general, container orchestration systems like Kubernetes are focused on building and deploying distributed systems made up of application containers. Consequently, we will focus on application containers for the remainder of this chapter.

Dockerfiles

A Dockerfile can be used to automate the creation of a Docker container image.

Let's start by building an application image for a simple Node.js program. This example would be very similar for many other dynamic languages, like Python or Ruby.

The simplest of npm/Node/Express apps has two files: *package.json* (Example 2-1) and *server.js* (Example 2-2). Put these in a directory and then run `npm install express --save` to establish a dependency on Express and install it.

Example 2-1. *package.json*

```
{
  "name": "simple-node",
  "version": "1.0.0",
  "description": "A sample simple application for Kubernetes Up & Running",
  "main": "server.js",
  "scripts": {
    "start": "node server.js"
  },
  "author": ""
}
```

Example 2-2. *server.js*

```
var express = require('express');

var app = express();
app.get('/', function (req, res) {
  res.send('Hello World!');
});
app.listen(3000, function () {
  console.log('Listening on port 3000!');
  console.log(' http://localhost:3000');
});
```

To package this up as a Docker image we need to create two additional files: *.dockerignore* (Example 2-3) and the Dockerfile (Example 2-4). The Dockerfile is a recipe for how to build the container image, while *.dockerignore* defines the set of files that should be ignored when copying files into the image. A full description of the syntax of the Dockerfile is available on the [Docker website](#).

Example 2-3. *.dockerignore*

```
node_modules
```

Example 2-4. *Dockerfile*

```
# Start from a Node.js 10 (LTS) image ❶
FROM node:10

# Specify the directory inside the image in which all commands will run ❷
WORKDIR /usr/src/app
```

```

# Copy package files and install dependencies ❸
COPY package*.json ./
RUN npm install

# Copy all of the app files into the image ❹
COPY . .

# The default command to run when starting the container ❺
CMD [ "npm", "start" ]

```

- ❶ Every Dockerfile builds on other container images. This line specifies that we are starting from the `node:10` image on the Docker Hub. This is a preconfigured image with Node.js 10.
- ❷ This line sets the work directory, in the container image, for all following commands.
- ❸ These two lines initialize the dependencies for Node.js. First we copy the package files into the image. This will include *package.json* and *package-lock.json*. The `RUN` command then runs the correct command *in the container* to install the necessary dependencies.
- ❹ Now we copy the rest of the program files into the image. This will include everything except *node_modules*, as that is excluded via the *.dockerignore* file.
- ❺ Finally, we specify the command that should be run when the container is run.

Run the following command to create the `simple-node` Docker image:

```
$ docker build -t simple-node .
```

When you want to run this image, you can do it with the following command. You can navigate to `http://localhost:3000` to access the program running in the container:

```
$ docker run --rm -p 3000:3000 simple-node
```

At this point our `simple-node` image lives in the local Docker registry where the image was built and is only accessible to a single machine. The true power of Docker comes from the ability to share images across thousands of machines and the broader Docker community.

Optimizing Image Sizes

There are several gotchas that come when people begin to experiment with container images that lead to overly large images. The first thing to remember is that files that are removed by subsequent layers in the system are actually still present in the images; they're just inaccessible. Consider the following situation:

```
.
└─ layer A: contains a large file named 'BigFile'
    └─ layer B: removes 'BigFile'
        └─ layer C: builds on B by adding a static binary
```

You might think that *BigFile* is no longer present in this image. After all, when you run the image, it is no longer accessible. But in fact it is still present in layer A, which means that whenever you push or pull the image, *BigFile* is still transmitted through the network, even if you can no longer access it.

Another pitfall that people fall into revolves around image caching and building. Remember that each layer is an independent delta from the layer below it. Every time you change a layer, it changes every layer that comes after it. Changing the preceding layers means that they need to be rebuilt, repushed, and repulled to deploy your image to development.

To understand this more fully, consider two images:

```
.
└─ layer A: contains a base OS
    └─ layer B: adds source code server.js
        └─ layer C: installs the 'node' package
```

versus:

```
.
└─ layer A: contains a base OS
    └─ layer B: installs the 'node' package
        └─ layer C: adds source code server.js
```

It seems obvious that both of these images will behave identically, and indeed the first time they are pulled they do. However, consider what happens when *server.js* changes. In one case, it is only the change that needs to be pulled or pushed, but in the other case, both *server.js* and the layer providing the node package need to be pulled and pushed, since the node layer is dependent on the *server.js* layer. In general, you want to order your layers from least likely to change to most likely to change in order to optimize the image size for pushing and pulling. This is why, in [Example 2-4](#), we copy the *package*.json* files and install dependencies before copying the rest of the program files. A developer is going to update and change the program files much more often than the dependencies.

Image Security

When it comes to security, there are no shortcuts. When building images that will ultimately run in a production Kubernetes cluster, be sure to follow best practices for packaging and distributing applications. For example, don't build containers with passwords baked in—and this includes not just in the final layer, but any layers in the image. One of the counterintuitive problems introduced by container layers is that deleting a file in one layer doesn't delete that file from preceding layers. It still takes

up space, and it can be accessed by anyone with the right tools—an enterprising attacker can simply create an image that only consists of the layers that contain the password.

Secrets and images should *never* be mixed. If you do so, you will be hacked, and you will bring shame to your entire company or department. We all want to be on TV someday, but there are better ways to go about that.

Multistage Image Builds

One of the most common ways to accidentally build large images is to do the actual program compilation as part of the construction of the application container image. Compiling code as part of the image build feels natural, and it is the easiest way to build a container image from your program. The trouble with doing this is that it leaves all of the unnecessary development tools, which are usually quite large, lying around inside of your image and slowing down your deployments.

To resolve this problem, Docker introduced *multistage builds*. With multistage builds, rather than producing a single image, a Docker file can actually produce multiple images. Each image is considered a stage. Artifacts can be copied from preceding stages to the current stage.

To illustrate this concretely, we will look at how to build our example application, `kuard`. This is a somewhat complicated application that involves a React.js frontend (with its own build process) that then gets embedded into a Go program. The Go program runs a backend API server that the React.js frontend interacts with.

A simple Dockerfile might look like this:

```
FROM golang:1.11-alpine

# Install Node and NPM
RUN apk update && apk upgrade && apk add --no-cache git nodejs bash npm

# Get dependencies for Go part of build
RUN go get -u github.com/jteeuwen/go-bindata/...
RUN go get github.com/tools/godep

WORKDIR /go/src/github.com/kubernetes-up-and-running/kuard

# Copy all sources in
COPY . .

# This is a set of variables that the build script expects
ENV VERBOSE=0
ENV PKG=github.com/kubernetes-up-and-running/kuard
ENV ARCH=amd64
ENV VERSION=test
```

```
# Do the build. This script is part of incoming sources.
RUN build/build.sh
```

```
CMD [ "/go/bin/kuard" ]
```

This Dockerfile produces a container image containing a static executable, but it also contains all of the Go development tools and the tools to build the React.js frontend and the source code for the application, neither of which are needed by the final application. The image, across all layers, adds up to over 500 MB.

To see how we would do this with multistage builds, examine this multistage Dockerfile:

```
# STAGE 1: Build
FROM golang:1.11-alpine AS build

# Install Node and NPM
RUN apk update && apk upgrade && apk add --no-cache git nodejs bash npm

# Get dependencies for Go part of build
RUN go get -u github.com/jteeuwen/go-bindata/...
RUN go get github.com/tools/godep

WORKDIR /go/src/github.com/kubernetes-up-and-running/kuard

# Copy all sources in
COPY . .

# This is a set of variables that the build script expects
ENV VERBOSE=0
ENV PKG=github.com/kubernetes-up-and-running/kuard
ENV ARCH=amd64
ENV VERSION=test

# Do the build. Script is part of incoming sources.
RUN build/build.sh

# STAGE 2: Deployment
FROM alpine

USER nobody:nobody
COPY --from=build /go/bin/kuard /kuard

CMD [ "/kuard" ]
```

This Dockerfile produces two images. The first is the *build* image, which contains the Go compiler, React.js toolchain, and source code for the program. The second is the *deployment* image, which simply contains the compiled binary. Building a container image using multistage builds can reduce your final container image size by hundreds of megabytes and thus dramatically speed up your deployment times, since generally,

deployment latency is gated on network performance. The final image produced from this Dockerfile is somewhere around 20 MB.

You can build and run this image with the following commands:

```
$ docker build -t kuard .  
$ docker run --rm -p 8080:8080 kuard
```

Storing Images in a Remote Registry

What good is a container image if it's only available on a single machine?

Kubernetes relies on the fact that images described in a Pod manifest are available across every machine in the cluster. One option for getting this image to all machines in the cluster would be to export the `kuard` image and import it on each of them. We can't think of anything more tedious than managing Docker images this way. The process of manually importing and exporting Docker images has human error written all over it. Just say no!

The standard within the Docker community is to store Docker images in a remote registry. There are tons of options when it comes to Docker registries, and what you choose will be largely based on your needs in terms of security and collaboration features.

Generally speaking, the first choice you need to make regarding a registry is whether to use a private or a public registry. Public registries allow anyone to download images stored in the registry, while private registries require authentication to download images. In choosing public versus private, it's helpful to consider your use case.

Public registries are great for sharing images with the world, because they allow for easy, unauthenticated use of the container images. You can easily distribute your software as a container image and have confidence that users everywhere will have the exact same experience.

In contrast, a private registry is best for storing applications that are private to your service and that you don't want the world to use.

Regardless, to push an image, you need to authenticate to the registry. You can generally do this with the `docker login` command, though there are some differences for certain registries. In the examples here we are pushing to the Google Cloud Platform registry, called the Google Container Registry (GCR); other clouds, including Azure and Amazon Web Services (AWS), also have hosted container registries. For new users hosting publicly readable images, the **Docker Hub** is a great place to start.

Once you are logged in, you can tag the `kuard` image by prepending the target Docker registry. You can also append another identifier that is usually used for the version or variant of that image, separated by a colon (`:`):

```
$ docker tag kuard gcr.io/kuar-demo/kuard-amd64:blue
```

Then you can push the kuard image:

```
$ docker push gcr.io/kuar-demo/kuard-amd64:blue
```

Now that the kuard image is available on a remote registry, it's time to deploy it using Docker. Because we pushed it to the public Docker registry, it will be available everywhere without authentication.

The Docker Container Runtime

Kubernetes provides an API for describing an application deployment, but relies on a container runtime to set up an application container using the container-specific APIs native to the target OS. On a Linux system that means configuring cgroups and namespaces. The interface to this container runtime is defined by the Container Runtime Interface (CRI) standard. The CRI API is implemented by a number of different programs, including the `containerd-cri` built by Docker and the `cri-o` implementation contributed by Red Hat.

Running Containers with Docker

Though generally in Kubernetes containers are launched by a daemon on each node called the *kubelet*, it's easier to get started with containers using the Docker command-line tool. The Docker CLI tool can be used to deploy containers. To deploy a container from the `gcr.io/kuar-demo/kuard-amd64:blue` image, run the following command:

```
$ docker run -d --name kuard \
  --publish 8080:8080 \
  gcr.io/kuar-demo/kuard-amd64:blue
```

This command starts the kuard container and maps ports 8080 on your local machine to 8080 in the container. The `--publish` option can be shortened to `-p`. This forwarding is necessary because each container gets its own IP address, so listening on *localhost* inside the container doesn't cause you to listen on your machine. Without the port forwarding, connections will be inaccessible to your machine. The `-d` option specifies that this should run in the background (daemon), while `--name kuard` gives the container a friendly name.

Exploring the kuard Application

kuard exposes a simple web interface, which you can load by pointing your browser at <http://localhost:8080> or via the command line:

```
$ curl http://localhost:8080
```

kuard also exposes a number of interesting functions that we will explore later on in this book.

Limiting Resource Usage

Docker provides the ability to limit the amount of resources used by applications by exposing the underlying cgroup technology provided by the Linux kernel. These capabilities are likewise used by Kubernetes to limit the resources used by each Pod.

Limiting memory resources

One of the key benefits to running applications within a container is the ability to restrict resource utilization. This allows multiple applications to coexist on the same hardware and ensures fair usage.

To limit kuard to 200 MB of memory and 1 GB of swap space, use the `--memory` and `--memory-swap` flags with the `docker run` command.

Stop and remove the current kuard container:

```
$ docker stop kuard
$ docker rm kuard
```

Then start another kuard container using the appropriate flags to limit memory usage:

```
$ docker run -d --name kuard \
  --publish 8080:8080 \
  --memory 200m \
  --memory-swap 1G \
  gcr.io/kuar-demo/kuard-amd64:blue
```

If the program in the container uses too much memory, it will be terminated.

Limiting CPU resources

Another critical resource on a machine is the CPU. Restrict CPU utilization using the `--cpu-shares` flag with the `docker run` command:

```
$ docker run -d --name kuard \
  --publish 8080:8080 \
  --memory 200m \
  --memory-swap 1G \
  --cpu-shares 1024 \
  gcr.io/kuar-demo/kuard-amd64:blue
```

Cleanup

Once you are done building an image, you can delete it with the `docker rmi` command:

```
docker rmi <tag-name>
```

or:

```
docker rmi <image-id>
```

Images can either be deleted via their tag name (e.g., `gcr.io/kuar-demo/kuar-damd64:blue`) or via their image ID. As with all ID values in the `docker` tool, the image ID can be shortened as long as it remains unique. Generally only three or four characters of the ID are necessary.

It's important to note that unless you explicitly delete an image it will live on your system forever, *even* if you build a new image with an identical name. Building this new image simply moves the tag to the new image; it doesn't delete or replace the old image.

Consequently, as you iterate while you are creating a new image, you will often create many, many different images that end up taking up unnecessary space on your computer.

To see the images currently on your machine, you can use the `docker images` command. You can then delete tags you are no longer using.

Docker provides a tool called `docker system prune` for doing general cleanup. This will remove all stopped containers, all untagged images, and all unused image layers cached as part of the build process. Use it carefully.

A slightly more sophisticated approach is to set up a `cron` job to run an image garbage collector. For example, the `docker-gc tool` is a commonly used image garbage collector that can easily run as a recurring `cron` job, once per day or once per hour, depending on how many images you are creating.

Summary

Application containers provide a clean abstraction for applications, and when packaged in the Docker image format, applications become easy to build, deploy, and distribute. Containers also provide isolation between applications running on the same machine, which helps avoid dependency conflicts.

In future chapters we'll see how the ability to mount external directories means we can run not only stateless applications in a container, but also applications like `mysql` and others that generate lots of data.

Deploying a Kubernetes Cluster

Now that you have successfully built an application container, the next step is to learn how to transform it into a complete, reliable, scalable distributed system. To do that, you need a working Kubernetes cluster. At this point, there are cloud-based Kubernetes services in most public clouds that make it easy to create a cluster with a few command-line instructions. We highly recommend this approach if you are just getting started with Kubernetes. Even if you are ultimately planning on running Kubernetes on bare metal, it's a good way to quickly get started with Kubernetes, learn about Kubernetes itself, and then learn how to install it on physical machines. Furthermore, managing a Kubernetes cluster is a complicated task in itself, and for most people it makes sense to defer this management to the cloud—especially when in most clouds the management service is free.

Of course, using a cloud-based solution requires paying for those cloud-based resources as well as having an active network connection to the cloud. For these reasons, local development can be more attractive, and in that case the `minikube` tool provides an easy-to-use way to get a local Kubernetes cluster up running in a VM on your local laptop or desktop. Though this is a nice option, `minikube` only creates a single-node cluster, which doesn't quite demonstrate all of the aspects of a complete Kubernetes cluster. For that reason, we recommend people start with a cloud-based solution, unless it really doesn't work for their situation. A more recent alternative is to run a Docker-in-Docker cluster, which can spin up a multi-node cluster on a single machine. This project is still in beta, though, so keep in mind that you may encounter unexpected issues.

If you truly insist on starting on bare metal, [Appendix A](#) at the end of this book gives instructions for building a cluster from a collection of Raspberry Pi single-board computers. These instructions use the `kubeadm` tool and can be adapted to other machines beyond Raspberry Pis.

Installing Kubernetes on a Public Cloud Provider

This chapter covers installing Kubernetes on the three major cloud providers: Amazon Web Services, Microsoft Azure, and the Google Cloud Platform.

If you choose to use a cloud provider to manage Kubernetes, you only need to install one of these options; once you have a cluster configured and ready to go you can skip to [“The Kubernetes Client” on page 31](#), unless you would prefer to install Kubernetes elsewhere.

Google Kubernetes Engine

The Google Cloud Platform offers a hosted Kubernetes-as-a-Service called Google Kubernetes Engine (GKE). To get started with GKE, you need a Google Cloud Platform account with billing enabled and the [gcloud tool](#) installed.

Once you have gcloud installed, first set a default zone:

```
$ gcloud config set compute/zone us-west1-a
```

Then you can create a cluster:

```
$ gcloud container clusters create kuar-cluster
```

This will take a few minutes. When the cluster is ready you can get credentials for the cluster using:

```
$ gcloud auth application-default login
```

If you run into trouble, you can find the complete instructions for creating a GKE cluster in the [Google Cloud Platform documentation](#).

Installing Kubernetes with Azure Kubernetes Service

Microsoft Azure offers a hosted Kubernetes-as-a-Service as part of the Azure Container Service. The easiest way to get started with Azure Container Service is to use the built-in Azure Cloud Shell in the Azure portal. You can activate the shell by clicking the shell icon in the upper-right toolbar:



The shell has the az tool automatically installed and configured to work with your Azure environment.

Alternatively, you can [install the az command-line interface \(CLI\) on your local machine](#).

When you have the shell up and working, you can run:

```
$ az group create --name=kuar --location=westus
```

Once the resource group is created, you can create a cluster using:

```
$ az aks create --resource-group=kuar --name=kuar-cluster
```

This will take a few minutes. Once the cluster is created, you can get credentials for the cluster with:

```
$ az aks get-credentials --resource-group=kuar --name=kuar-cluster
```

If you don't already have the `kubectl` tool installed, you can install it using:

```
$ az aks install-cli
```

You can find complete instructions for installing Kubernetes on Azure in the [Azure documentation](#).

Installing Kubernetes on Amazon Web Services

Amazon offers a managed Kubernetes service called Elastic Kubernetes Service (EKS). The easiest way to create an EKS cluster is via the [open source eksctl command-line tool](#).

Once you have `eksctl` installed and in your path, you can run the following command to create a cluster:

```
$ eksctl create cluster --name kuar-cluster ...
```

For more details on installation options (such as node size and more), view the help using this command:

```
$ eksctl create cluster --help
```

The cluster installation includes the right configuration for the `kubectl` command-line tool. If you don't already have `kubectl` installed, you can follow the instructions in the [documentation](#).

Installing Kubernetes Locally Using minikube

If you need a local development experience, or you don't want to pay for cloud resources, you can install a simple single-node cluster using `minikube`.

Alternatively, if you have already installed Docker Desktop, it comes bundled with a single-machine installation of Kubernetes.

While `minikube` (or Docker Desktop) is a good simulation of a Kubernetes cluster, it's really intended for local development, learning, and experimentation. Because it only runs in a VM on a single node, it doesn't provide the reliability of a distributed Kubernetes cluster.

In addition, certain features described in this book require integration with a cloud provider. These features are either not available or work in a limited way with `minikube`.



You need to have a hypervisor installed on your machine to use `minikube`. For Linux and macOS, this is generally `virtualbox`. On Windows, the Hyper-V hypervisor is the default option. Make sure you install the hypervisor before using `minikube`.

You can find the `minikube` tool on [GitHub](#). There are binaries for Linux, macOS, and Windows that you can download. Once you have the `minikube` tool installed, you can create a local cluster using:

```
$ minikube start
```

This will create a local VM, provision Kubernetes, and create a local `kubectl` configuration that points to that cluster.

When you are done with your cluster, you can stop the VM with:

```
$ minikube stop
```

If you want to remove the cluster, you can run:

```
$ minikube delete
```

Running Kubernetes in Docker

A different approach to running a Kubernetes cluster has been developed more recently, which uses Docker containers to simulate multiple Kubernetes nodes instead of running everything in a virtual machine. The [kind project](#) provides a great experience for launching and managing test clusters in Docker. (*kind* stands for Kubernetes IN Docker.) `kind` is still a work in progress (pre 1.0), but is widely used by those building Kubernetes for fast and easy testing.

Installation instructions for your platform can be found [at the kind site](#). Once you get it installed, creating a cluster is as easy as:

```
$ kind create cluster --wait 5m \  
$ export KUBECONFIG="$(kind get kubeconfig-path)"  
$ kubectl cluster-info  
$ kind delete cluster
```

Running Kubernetes on Raspberry Pi

If you want to experiment with a realistic Kubernetes cluster but don't want to pay a lot, a very nice Kubernetes cluster can be built on top of Raspberry Pi computers for a relatively small cost. The details of building such a cluster are out of scope for this chapter, but they are given in [Appendix A](#) at the end of this book.

The Kubernetes Client

The official Kubernetes client is `kubectl`: a command-line tool for interacting with the Kubernetes API. `kubectl` can be used to manage most Kubernetes objects, such as Pods, ReplicaSets, and Services. `kubectl` can also be used to explore and verify the overall health of the cluster.

We'll use the `kubectl` tool to explore the cluster you just created.

Checking Cluster Status

The first thing you can do is check the version of the cluster that you are running:

```
$ kubectl version
```

This will display two different versions: the version of the local `kubectl` tool, as well as the version of the Kubernetes API server.



Don't worry if these versions are different. The Kubernetes tools are backward- and forward-compatible with different versions of the Kubernetes API, so long as you stay within two minor versions for both the tools and the cluster and don't try to use newer features on an older cluster. Kubernetes follows the semantic versioning specification, where the minor version is the middle number (e.g., the 5 in 1.5.2).

Now that we've established that you can communicate with your Kubernetes cluster, we'll explore the cluster in more depth.

First, you can get a simple diagnostic for the cluster. This is a good way to verify that your cluster is generally healthy:

```
$ kubectl get componentstatuses
```

The output should look like this:

NAME	STATUS	MESSAGE	ERROR
scheduler	Healthy	ok	
controller-manager	Healthy	ok	
etcd-0	Healthy	{"health": "true"}	



As Kubernetes changes and improves over time, the output of the `kubectl` command sometimes changes. Don't worry if the output doesn't look exactly identical to what is shown in the examples in this book.

You can see here the components that make up the Kubernetes cluster. The `controller-manager` is responsible for running various controllers that regulate behavior in the cluster; for example, ensuring that all of the replicas of a service are available and healthy. The scheduler is responsible for placing different Pods onto different nodes in the cluster. Finally, the `etcd` server is the storage for the cluster where all of the API objects are stored.

Listing Kubernetes Worker Nodes

Next, you can list out all of the nodes in your cluster:

```
$ kubectl get nodes
NAME                STATUS    AGE           VERSION
kubernetes          Ready,   45d           v1.12.1
node-1              Ready    45d           v1.12.1
node-2              Ready    45d           v1.12.1
node-3              Ready    45d           v1.12.1
```

You can see this is a four-node cluster that's been up for 45 days. In Kubernetes, nodes are separated into `master` nodes that contain containers like the API server, scheduler, etc., which manage the cluster, and `worker` nodes where your containers will run. Kubernetes won't generally schedule work onto `master` nodes to ensure that user workloads don't harm the overall operation of the cluster.

You can use the `kubectl describe` command to get more information about a specific node, such as `node-1`:

```
$ kubectl describe nodes node-1
```

First, you see basic information about the node:

```
Name:                node-1
Role:
Labels:              beta.kubernetes.io/arch=arm
                    beta.kubernetes.io/os=linux
                    kubernetes.io/hostname=node-1
```

You can see that this node is running the Linux OS and is running on an ARM processor.

Next, you see information about the operation of `node-1` itself:

Conditions:

Type	Status	LastHeartbeatTime	Reason	Message
OutOfDisk	False	Sun, 05 Feb 2017...	KubeletHasSufficientDisk	kubelet...
MemoryPressure	False	Sun, 05 Feb 2017...	KubeletHasSufficientMemory	kubelet...
DiskPressure	False	Sun, 05 Feb 2017...	KubeletHasNoDiskPressure	kubelet...
Ready	True	Sun, 05 Feb 2017...	KubeletReady	kubelet...

These statuses show that the node has sufficient disk and memory space and is reporting that it is healthy to the Kubernetes master. Next, there is information about the capacity of the machine:

Capacity:

alpha.kubernetes.io/nvidia-gpu:	0
cpu:	4
memory:	882636Ki
Pods:	110

Allocatable:

alpha.kubernetes.io/nvidia-gpu:	0
cpu:	4
memory:	882636Ki
Pods:	110

Then there is information about the software on the node, including the version of Docker that is running, the versions of Kubernetes and the Linux kernel, and more:

System Info:

Machine ID:	9122895d0d494e3f97dda1e8f969c85c
System UUID:	A7DBF2CE-DB1E-E34A-969A-3355C36A2149
Boot ID:	ba53d5ee-27d2-4b6a-8f19-e5f702993ec6
Kernel Version:	4.15.0-1037-azure
OS Image:	Ubuntu 16.04.5 LTS
Operating System:	linux
Architecture:	amd64
Container Runtime Version:	docker://3.0.4
Kubelet Version:	v1.12.6
Kube-Proxy Version:	v1.12.6
PodCIDR:	10.244.1.0/24

Finally, there is information about the Pods that are currently running on this node:

Non-terminated Pods:		(3 in total)			
Namespace	Name	CPU Requests	CPU Limits	Memory Requests	Memory Limits
kube-system	kube-dns...	260m (6%)	0 (0%)	140Mi (16%)	220Mi (25%)
kube-system	kube-fla...	0 (0%)	0 (0%)	0 (0%)	0 (0%)
kube-system	kube-pro...	0 (0%)	0 (0%)	0 (0%)	0 (0%)

Allocated resources:
(Total limits may be over 100 percent, i.e., overcommitted.)

CPU Requests	CPU Limits	Memory Requests	Memory Limits
260m (6%)	0 (0%)	140Mi (16%)	220Mi (25%)

No events.

From this output you can see the Pods on the node (e.g., the kube-dns Pod that supplies DNS services for the cluster), the CPU and memory that each Pod is requesting from the node, as well as the total resources requested. It's worth noting here that Kubernetes tracks both the *requests* and upper *limits* for resources for each Pod that runs on a machine. The difference between requests and limits is described in detail in [Chapter 5](#), but in a nutshell, resources requested by a Pod are guaranteed to be present on the node, while a Pod's limit is the maximum amount of a given resource that a Pod can consume. A Pod's limit can be higher than its request, in which case the extra resources are supplied on a best-effort basis. They are not guaranteed to be present on the node.

Cluster Components

One of the interesting aspects of Kubernetes is that many of the components that make up the Kubernetes cluster are actually deployed using Kubernetes itself. We'll take a look at a few of these. These components use a number of the concepts that we'll introduce in later chapters. All of these components run in the kube-system namespace.¹

Kubernetes Proxy

The Kubernetes proxy is responsible for routing network traffic to load-balanced services in the Kubernetes cluster. To do its job, the proxy must be present on every node in the cluster. Kubernetes has an API object named DaemonSet, which you will learn about later in the book, that is used in many clusters to accomplish this. If your cluster runs the Kubernetes proxy with a DaemonSet, you can see the proxies by running:

```
$ kubectl get daemonSets --namespace=kube-system kube-proxy
NAME           DESIRED   CURRENT   READY   NODE-SELECTOR   AGE
kube-proxy     4         4         4       <none>          45d
```

Depending on how your cluster is set up, the DaemonSet for the kube-proxy may be named something else, or it's possible that it won't use a DaemonSet at all. Regardless, the kube-proxy container should be running on all nodes in a cluster.

Kubernetes DNS

Kubernetes also runs a DNS server, which provides naming and discovery for the services that are defined in the cluster. This DNS server also runs as a replicated service on the cluster. Depending on the size of your cluster, you may see one or more

¹ As you'll learn in the next chapter, a namespace in Kubernetes is an entity for organizing Kubernetes resources. You can think of it like a folder in a filesystem.

DNS servers running in your cluster. The DNS service is run as a Kubernetes deployment, which manages these replicas:

```
$ kubectl get deployments --namespace=kube-system core-dns
NAME          DESIRED  CURRENT  UP-TO-DATE  AVAILABLE  AGE
core-dns     1         1         1             1           45d
```

There is also a Kubernetes service that performs load balancing for the DNS server:

```
$ kubectl get services --namespace=kube-system core-dns
NAME          CLUSTER-IP  EXTERNAL-IP  PORT(S)      AGE
core-dns     10.96.0.10  <none>       53/UDP,53/TCP 45d
```

This shows that the DNS service for the cluster has the address 10.96.0.10. If you log in to a container in the cluster, you'll see that this has been populated into the `/etc/resolv.conf` file for the container.



With Kubernetes 1.12, Kubernetes transitioned from the kube-dns DNS server to the core-dns DNS server. Because of this, if you are running an older Kubernetes cluster, you may see kube-dns instead.

Kubernetes UI

The final Kubernetes component is a GUI. The UI is run as a single replica, but it is still managed by a Kubernetes deployment for reliability and upgrades. You can see this UI server using:

```
$ kubectl get deployments --namespace=kube-system kubernetes-dashboard
NAME          DESIRED  CURRENT  UP-TO-DATE  AVAILABLE  AGE
kubernetes-dashboard 1         1         1             1           45d
```

The dashboard also has a service that performs load balancing for the dashboard:

```
$ kubectl get services --namespace=kube-system kubernetes-dashboard
NAME          CLUSTER-IP  EXTERNAL-IP  PORT(S)      AGE
kubernetes-dashboard 10.99.104.174 <nodes>      80:32551/TCP 45d
```

You can use `kubectl proxy` to access this UI. Launch the Kubernetes proxy using:

```
$ kubectl proxy
```

This starts up a server running on `localhost:8001`. If you visit <http://localhost:8001/api/v1/namespaces/kubernetes-dashboard/services/https:kubernetes-dashboard:/proxy/> in your web browser, you should see the Kubernetes web UI. You can use this interface to explore your cluster, as well as create new containers. The full details of this interface are outside of the scope of this book, and it is changing rapidly as the dashboard is improved.

Some providers don't install the Kubernetes dashboard by default, so don't worry if you don't see it in your cluster. Documentation on how to install the dashboard for these clusters is available at <https://kubernetes.io/docs/tasks/access-application-cluster/web-ui-dashboard/>.

Summary

Hopefully at this point you have a Kubernetes cluster (or three) up and running and you've used a few commands to explore the cluster you have created. Next, we'll spend some more time exploring the command-line interface to that Kubernetes cluster and teach you how to master the `kubectl` tool. Throughout the rest of the book, you'll be using `kubectl` and your test cluster to explore the various objects in the Kubernetes API.

Common kubectl Commands

The `kubectl` command-line utility is a powerful tool, and in the following chapters you will use it to create objects and interact with the Kubernetes API. Before that, however, it makes sense to go over the basic `kubectl` commands that apply to all Kubernetes objects.

Namespaces

Kubernetes uses *namespaces* to organize objects in the cluster. You can think of each namespace as a folder that holds a set of objects. By default, the `kubectl` command-line tool interacts with the `default` namespace. If you want to use a different namespace, you can pass `kubectl` the `--namespace` flag. For example, `kubectl --namespace=mystuff` references objects in the `mystuff` namespace. If you want to interact with all namespaces—for example, to list all Pods in your cluster—you can pass the `--all-namespaces` flag.

Contexts

If you want to change the default namespace more permanently, you can use a *context*. This gets recorded in a `kubectl` configuration file, usually located at `$HOME/.kube/config`. This configuration file also stores how to both find and authenticate to your cluster. For example, you can create a context with a different default namespace for your `kubectl` commands using:

```
$ kubectl config set-context my-context --namespace=mystuff
```

This creates a new context, but it doesn't actually start using it yet. To use this newly created context, you can run:

```
$ kubectl config use-context my-context
```

Contexts can also be used to manage different clusters or different users for authenticating to those clusters using the `--users` or `--clusters` flags with the `set-context` command.

Viewing Kubernetes API Objects

Everything contained in Kubernetes is represented by a RESTful resource. Throughout this book, we refer to these resources as *Kubernetes objects*. Each Kubernetes object exists at a unique HTTP path; for example, `https://your-k8s.com/api/v1/namespaces/default/pods/my-pod` leads to the representation of a Pod in the default namespace named `my-pod`. The `kubectl` command makes HTTP requests to these URLs to access the Kubernetes objects that reside at these paths.

The most basic command for viewing Kubernetes objects via `kubectl` is `get`. If you run `kubectl get <resource-name>` you will get a listing of all resources in the current namespace. If you want to get a specific resource, you can use `kubectl get <resource-name> <obj-name>`.

By default, `kubectl` uses a human-readable printer for viewing the responses from the API server, but this human-readable printer removes many of the details of the objects to fit each object on one terminal line. One way to get slightly more information is to add the `-o wide` flag, which gives more details, on a longer line. If you want to view the complete object, you can also view the objects as raw JSON or YAML using the `-o json` or `-o yaml` flags, respectively.

A common option for manipulating the output of `kubectl` is to remove the headers, which is often useful when combining `kubectl` with Unix pipes (e.g., `kubectl ... | awk ...`). If you specify the `--no-headers` flag, `kubectl` will skip the headers at the top of the human-readable table.

Another common task is extracting specific fields from the object. `kubectl` uses the JSONPath query language to select fields in the returned object. The complete details of JSONPath are beyond the scope of this chapter, but as an example, this command will extract and print the IP address of the specified Pod:

```
$ kubectl get pods my-pod -o jsonpath --template={.status.podIP}
```

If you are interested in more detailed information about a particular object, use the `describe` command:

```
$ kubectl describe <resource-name> <obj-name>
```

This will provide a rich multiline human-readable description of the object as well as any other relevant, related objects and events in the Kubernetes cluster.

Creating, Updating, and Destroying Kubernetes Objects

Objects in the Kubernetes API are represented as JSON or YAML files. These files are either returned by the server in response to a query or posted to the server as part of an API request. You can use these YAML or JSON files to create, update, or delete objects on the Kubernetes server.

Let's assume that you have a simple object stored in *obj.yaml*. You can use `kubectl` to create this object in Kubernetes by running:

```
$ kubectl apply -f obj.yaml
```

Notice that you don't need to specify the resource type of the object; it's obtained from the object file itself.

Similarly, after you make changes to the object, you can use the `apply` command again to update the object:

```
$ kubectl apply -f obj.yaml
```

The `apply` tool will only modify objects that are different from the current objects in the cluster. If the objects you are creating already exist in the cluster, it will simply exit successfully without making any changes. This makes it useful for loops where you want to ensure the state of the cluster matches the state of the filesystem. You can repeatedly use `apply` to reconcile state.

If you want to see what the `apply` command will do without actually making the changes, you can use the `--dry-run` flag to print the objects to the terminal without actually sending them to the server.



If you feel like making interactive edits instead of editing a local file, you can instead use the `edit` command, which will download the latest object state and then launch an editor that contains the definition:

```
$ kubectl edit <resource-name> <obj-name>
```

After you save the file, it will be automatically uploaded back to the Kubernetes cluster.

The `apply` command also records the history of previous configurations in an annotation within the object. You can manipulate these records with the `edit-last-applied`, `set-last-applied`, and `view-last-applied` commands. For example:

```
$ kubectl apply -f myobj.yaml view-last-applied
```

will show you the last state that was applied to the object.

When you want to delete an object, you can simply run:

```
$ kubectl delete -f obj.yaml
```

It is important to note that `kubectl` will not prompt you to confirm the deletion. Once you issue the command, the object *will* be deleted.

Likewise, you can delete an object using the resource type and name:

```
$ kubectl delete <resource-name> <obj-name>
```

Labeling and Annotating Objects

Labels and annotations are tags for your objects. We'll discuss the differences in [Chapter 6](#), but for now, you can update the labels and annotations on any Kubernetes object using the `annotate` and `label` commands. For example, to add the `color=red` label to a Pod named `bar`, you can run:

```
$ kubectl label pods bar color=red
```

The syntax for annotations is identical.

By default, `label` and `annotate` will not let you overwrite an existing label. To do this, you need to add the `--overwrite` flag.

If you want to remove a label, you can use the `<label-name>-` syntax:

```
$ kubectl label pods bar color-
```

This will remove the `color` label from the Pod named `bar`.

Debugging Commands

`kubectl` also makes a number of commands available for debugging your containers. You can use the following to see the logs for a running container:

```
$ kubectl logs <pod-name>
```

If you have multiple containers in your Pod, you can choose the container to view using the `-c` flag.

By default, `kubectl logs` lists the current logs and exits. If you instead want to continuously stream the logs back to the terminal without exiting, you can add the `-f` (follow) command-line flag.

You can also use the `exec` command to execute a command in a running container:

```
$ kubectl exec -it <pod-name> -- bash
```

This will provide you with an interactive shell inside the running container so that you can perform more debugging.

If you don't have `bash` or some other terminal available within your container, you can always attach to the running process:

```
$ kubectl attach -it <pod-name>
```

This will attach to the running process. It is similar to `kubectl logs` but will allow you to send input to the running process, assuming that process is set up to read from standard input.

You can also copy files to and from a container using the `cp` command:

```
$ kubectl cp <pod-name>:</path/to/remote/file> </path/to/local/file>
```

This will copy a file from a running container to your local machine. You can also specify directories, or reverse the syntax to copy a file from your local machine back out into the container.

If you want to access your Pod via the network, you can use the `port-forward` command to forward network traffic from the local machine to the Pod. This enables you to securely tunnel network traffic through to containers that might not be exposed anywhere on the public network. For example, the following command:

```
$ kubectl port-forward <pod-name> 8080:80
```

opens up a connection that forwards traffic from the local machine on port 8080 to the remote container on port 80.



You can also use the `port-forward` command with services by specifying `services/<service-name>` instead of `<pod-name>`, but note that if you do `port-forward` to a service, the requests will only ever be forwarded to a single Pod in that service. They will not go through the service load balancer.

Finally, if you are interested in how your cluster is using resources, you can use the `top` command to see the list of resources in use by either nodes or Pods. This command:

```
kubectl top nodes
```

will display the total CPU and memory in use by the nodes in terms of both absolute units (e.g., cores) and percentage of available resources (e.g., total number of cores). Similarly, this command:

```
kubectl top pods
```

will show all Pods and their resource usage. By default it only displays Pods in the current namespace, but you can add the `--all-namespaces` flag to see resource usage by all Pods in the cluster.

Command Autocompletion

kubectl supports integration with your shell to enable tab completion for both commands and resources. Depending on your environment, you may need to install the bash-completion package before you activate command autocompletion. You can do this using the appropriate package manager:

```
# macOS
brew install bash-completion

# CentOS/Red Hat
yum install bash-completion

# Debian/Ubuntu
apt-get install bash-completion
```

When installing on macOS, make sure to follow the instructions from brew about how to activate tab completion using your ``${HOME}/.bash_profile``.

Once bash-completion is installed, you can temporarily activate it for your terminal using:

```
source <(kubectl completion bash)
```

To make this automatic for every terminal, you can add it to your ``${HOME}/.bashrc`` file:

```
echo "source <(kubectl completion bash)" >> `${HOME}/.bashrc
```

If you use zsh you can find similar instructions [online](#).

Alternative Ways of Viewing Your Cluster

In addition to kubectl, there are other tools for interacting with your Kubernetes cluster.

For example, there are plug-ins for several editors that integrate Kubernetes and the editor environment, including:

- [Visual Studio Code](#)
- [IntelliJ](#)
- [Eclipse](#)

Additionally, there is an [open source mobile application](#) that allows you to access your cluster from your phone.

Summary

`kubectl` is a powerful tool for managing your applications in your Kubernetes cluster. This chapter has illustrated many of the common uses for the tool, but `kubectl` has a great deal of built-in help available. You can start viewing this help with:

```
$ kubectl help
```

or:

```
$ kubectl help <command-name>
```

In earlier chapters we discussed how you might go about containerizing your application, but in real-world deployments of containerized applications you will often want to colocate multiple applications into a single atomic unit, scheduled onto a single machine.

A canonical example of such a deployment is illustrated in [Figure 5-1](#), which consists of a container serving web requests and a container synchronizing the filesystem with a remote Git repository.

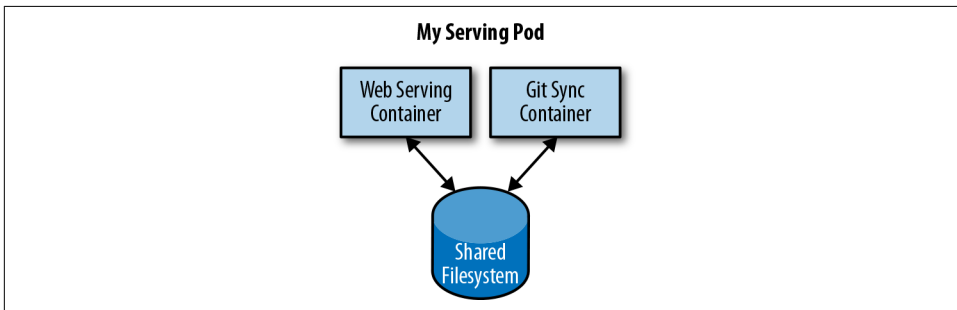

Figure 5-1. An example Pod with two containers and a shared filesystem

At first, it might seem tempting to wrap up both the web server and the Git synchronizer into a single container. After closer inspection, however, the reasons for the separation become clear. First, the two different containers have significantly different requirements in terms of resource usage. Take, for example, memory. Because the web server is serving user requests, we want to ensure that it is always available and responsive. On the other hand, the Git synchronizer isn't really user-facing and has a "best effort" quality of service.

Suppose that our Git synchronizer has a memory leak. We need to ensure that the Git synchronizer cannot use up memory that we want to use for our web server, since this can affect web server performance or even crash the server.

This sort of resource isolation is exactly the sort of thing that containers are designed to accomplish. By separating the two applications into two separate containers, we can ensure reliable web server operation.

Of course, the two containers are quite symbiotic; it makes no sense to schedule the web server on one machine and the Git synchronizer on another. Consequently, Kubernetes groups multiple containers into a single atomic unit called a *Pod*. (The name goes with the whale theme of Docker containers, since a Pod is also a group of whales.)



Though the concept of such sidecars seemed controversial or confusing when it was first introduced in Kubernetes, it has subsequently been adopted by a variety of different applications to deploy their infrastructure. For example, several Service Mesh implementations use sidecars to inject network management into an application's Pod.

Pods in Kubernetes

A Pod represents a collection of application containers and volumes running in the same execution environment. Pods, not containers, are the smallest deployable artifact in a Kubernetes cluster. This means all of the containers in a Pod always land on the same machine.

Each container within a Pod runs in its own cgroup, but they share a number of Linux namespaces.

Applications running in the same Pod share the same IP address and port space (network namespace), have the same hostname (UTS namespace), and can communicate using native interprocess communication channels over System V IPC or POSIX message queues (IPC namespace). However, applications in different Pods are isolated from each other; they have different IP addresses, different hostnames, and more. Containers in different Pods running on the same node might as well be on different servers.

Thinking with Pods

One of the most common questions that occurs in the adoption of Kubernetes is “What should I put in a Pod?”

Sometimes people see Pods and think, “Aha! A WordPress container and a MySQL database container should be in the same Pod.” However, this kind of Pod is actually an example of an anti-pattern for Pod construction. There are two reasons for this. First, WordPress and its database are not truly symbiotic. If the WordPress container and the database container land on different machines, they still can work together quite effectively, since they communicate over a network connection. Secondly, you don’t necessarily want to scale WordPress and the database as a unit. WordPress itself is mostly stateless, and thus you may want to scale your WordPress frontends in response to frontend load by creating more WordPress Pods. Scaling a MySQL database is much trickier, and you would be much more likely to increase the resources dedicated to a single MySQL Pod. If you group the WordPress and MySQL containers together in a single Pod, you are forced to use the same scaling strategy for both containers, which doesn’t fit well.

In general, the right question to ask yourself when designing Pods is, “Will these containers work correctly if they land on different machines?” If the answer is “no,” a Pod is the correct grouping for the containers. If the answer is “yes,” multiple Pods is probably the correct solution. In the example at the beginning of this chapter, the two containers interact via a local filesystem. It would be impossible for them to operate correctly if the containers were scheduled on different machines.

In the remaining sections of this chapter, we will describe how to create, introspect, manage, and delete Pods in Kubernetes.

The Pod Manifest

Pods are described in a Pod manifest. The Pod manifest is just a text-file representation of the Kubernetes API object. Kubernetes strongly believes in *declarative configuration*. Declarative configuration means that you write down the desired state of the world in a configuration and then submit that configuration to a service that takes actions to ensure the desired state becomes the actual state.



Declarative configuration is different from *imperative configuration*, where you simply take a series of actions (e.g., `apt-get install foo`) to modify the world. Years of production experience have taught us that maintaining a written record of the system’s desired state leads to a more manageable, reliable system. Declarative configuration enables numerous advantages, including code review for configurations as well as documenting the current state of the world for distributed teams. Additionally, it is the basis for all of the self-healing behaviors in Kubernetes that keep applications running without user action.

The Kubernetes API server accepts and processes Pod manifests before storing them in persistent storage (etcd). The scheduler also uses the Kubernetes API to find Pods that haven't been scheduled to a node. The scheduler then places the Pods onto nodes depending on the resources and other constraints expressed in the Pod manifests. Multiple Pods can be placed on the same machine as long as there are sufficient resources. However, scheduling multiple replicas of the same application onto the same machine is worse for reliability, since the machine is a single failure domain. Consequently, the Kubernetes scheduler tries to ensure that Pods from the same application are distributed onto different machines for reliability in the presence of such failures. Once scheduled to a node, Pods don't move and must be explicitly destroyed and rescheduled.

Multiple instances of a Pod can be deployed by repeating the workflow described here. However, ReplicaSets (Chapter 9) are better suited for running multiple instances of a Pod. (It turns out they're also better at running a single Pod, but we'll get into that later.)

Creating a Pod

The simplest way to create a Pod is via the imperative `kubectl run` command. For example, to run our same `kuard` server, use:

```
$ kubectl run kuard --generator=run-pod/v1 \
  --image=gcr.io/kuar-demo/kuard-amd64:blue
```

You can see the status of this Pod by running:

```
$ kubectl get pods
```

You may initially see the container as `Pending`, but eventually you will see it transition to `Running`, which means that the Pod and its containers have been successfully created.

For now, you can delete this Pod by running:

```
$ kubectl delete pods/kuard
```

We will now move on to writing a complete Pod manifest by hand.

Creating a Pod Manifest

Pod manifests can be written using YAML or JSON, but YAML is generally preferred because it is slightly more human-editable and has the ability to add comments. Pod manifests (and other Kubernetes API objects) should really be treated in the same way as source code, and things like comments help explain the Pod to new team members who are looking at them for the first time.

Pod manifests include a couple of key fields and attributes: namely a `metadata` section for describing the Pod and its labels, a `spec` section for describing volumes, and a list of containers that will run in the Pod.

In [Chapter 2](#) we deployed `kuard` using the following Docker command:

```
$ docker run -d --name kuard \  
  --publish 8080:8080 \  
  gcr.io/kuar-demo/kuard-amd64:blue
```

A similar result can be achieved by instead writing [Example 5-1](#) to a file named `kuard-pod.yaml` and then using `kubectl` commands to load that manifest to Kubernetes.

Example 5-1. `kuard-pod.yaml`

```
apiVersion: v1  
kind: Pod  
metadata:  
  name: kuard  
spec:  
  containers:  
    - image: gcr.io/kuar-demo/kuard-amd64:blue  
      name: kuard  
      ports:  
        - containerPort: 8080  
          name: http  
          protocol: TCP
```

Running Pods

In the previous section we created a Pod manifest that can be used to start a Pod running `kuard`. Use the `kubectl apply` command to launch a single instance of `kuard`:

```
$ kubectl apply -f kuard-pod.yaml
```

The Pod manifest will be submitted to the Kubernetes API server. The Kubernetes system will then schedule that Pod to run on a healthy node in the cluster, where it will be monitored by the `kubelet` daemon process. Don't worry if you don't understand all the moving parts of Kubernetes right now; we'll get into more details throughout the book.

Listing Pods

Now that we have a Pod running, let's go find out some more about it. Using the `kubectl` command-line tool, we can list all Pods running in the cluster. For now, this should only be the single Pod that we created in the previous step:

```
$ kubectl get pods
NAME      READY   STATUS    RESTARTS   AGE
kuard     1/1     Running   0           44s
```

You can see the name of the Pod (kuard) that we gave it in the previous YAML file. In addition to the number of ready containers (1/1), the output also shows the status, the number of times the Pod was restarted, as well as the age of the Pod.

If you ran this command immediately after the Pod was created, you might see:

```
NAME      READY   STATUS    RESTARTS   AGE
kuard     0/1     Pending   0           1s
```

The Pending state indicates that the Pod has been submitted but hasn't been scheduled yet.

If a more significant error occurs (e.g., an attempt to create a Pod with a container image that doesn't exist), it will also be listed in the status field.



By default, the `kubectl` command-line tool tries to be concise in the information it reports, but you can get more information via command-line flags. Adding `-o wide` to any `kubectl` command will print out slightly more information (while still trying to keep the information to a single line). Adding `-o json` or `-o yaml` will print out the complete objects in JSON or YAML, respectively.

Pod Details

Sometimes, the single-line view is insufficient because it is too terse. Additionally, Kubernetes maintains numerous events about Pods that are present in the event stream, not attached to the Pod object.

To find out more information about a Pod (or any Kubernetes object) you can use the `kubectl describe` command. For example, to describe the Pod we previously created, you can run:

```
$ kubectl describe pods kuard
```

This outputs a bunch of information about the Pod in different sections. At the top is basic information about the Pod:

```
Name:          kuard
Namespace:     default
Node:          node1/10.0.15.185
Start Time:    Sun, 02 Jul 2017 15:00:38 -0700
Labels:        <none>
Annotations:   <none>
Status:        Running
IP:           192.168.199.238
Controllers:   <none>
```

Then there is information about the containers running in the Pod:

```
Containers:
  kuard:
    Container ID:  docker://055095...
    Image:          gcr.io/kuar-demo/kuard-amd64:blue
    Image ID:      docker-pullable://gcr.io/kuar-demo/kuard-amd64@sha256:a580...
    Port:          8080/TCP
    State:         Running
      Started:     Sun, 02 Jul 2017 15:00:41 -0700
    Ready:         True
    Restart Count: 0
    Environment:   <none>
    Mounts:
      /var/run/secrets/kubernetes.io/serviceaccount from default-token-cg5f5 (ro)
```

Finally, there are events related to the Pod, such as when it was scheduled, when its image was pulled, and if/when it had to be restarted because of failing health checks:

```
Events:
  Seen From          SubObjectPath          Type    Reason    Message
  ----
  50s default-scheduler                Normal  Scheduled Success...
  49s kubelet, node1  spec.containers{kuard} Normal  Pulling  pulling...
  47s kubelet, node1  spec.containers{kuard} Normal  Pulled   Success...
  47s kubelet, node1  spec.containers{kuard} Normal  Created  Created...
  47s kubelet, node1  spec.containers{kuard} Normal  Started  Started...
```

Deleting a Pod

When it is time to delete a Pod, you can delete it either by name:

```
$ kubectl delete pods/kuard
```

or using the same file that you used to create it:

```
$ kubectl delete -f kuard-pod.yaml
```

When a Pod is deleted, it is *not* immediately killed. Instead, if you run `kubectl get pods` you will see that the Pod is in the `Terminating` state. All Pods have a termination *grace period*. By default, this is 30 seconds. When a Pod is transitioned to `Terminating` it no longer receives new requests. In a serving scenario, the grace period is important for reliability because it allows the Pod to finish any active requests that it may be in the middle of processing before it is terminated.

It's important to note that when you delete a Pod, any data stored in the containers associated with that Pod will be deleted as well. If you want to persist data across multiple instances of a Pod, you need to use `PersistentVolumes`, described at the end of this chapter.

Accessing Your Pod

Now that your Pod is running, you're going to want to access it for a variety of reasons. You may want to load the web service that is running in the Pod. You may want to view its logs to debug a problem that you are seeing, or even execute other commands in the context of the Pod to help debug. The following sections detail various ways that you can interact with the code and data running inside your Pod.

Using Port Forwarding

Later in the book, we'll show how to expose a service to the world or other containers using load balancers—but oftentimes you simply want to access a specific Pod, even if it's not serving traffic on the internet.

To achieve this, you can use the port-forwarding support built into the Kubernetes API and command-line tools.

When you run:

```
$ kubectl port-forward kuard 8080:8080
```

a secure tunnel is created from your local machine, through the Kubernetes master, to the instance of the Pod running on one of the worker nodes.

As long as the `port-forward` command is still running, you can access the Pod (in this case the `kuard` web interface) at <http://localhost:8080>.

Getting More Info with Logs

When your application needs debugging, it's helpful to be able to dig deeper than describe to understand what the application is doing. Kubernetes provides two commands for debugging running containers. The `kubectl logs` command downloads the current logs from the running instance:

```
$ kubectl logs kuard
```

Adding the `-f` flag will cause you to continuously stream logs.

The `kubectl logs` command always tries to get logs from the currently running container. Adding the `--previous` flag will get logs from a previous instance of the container. This is useful, for example, if your containers are continuously restarting due to a problem at container startup.



While using `kubectl logs` is useful for one-off debugging of containers in production environments, it's generally useful to use a log aggregation service. There are several open source log aggregation tools, like `fluentd` and `elasticsearch`, as well as numerous cloud logging providers. Log aggregation services provide greater capacity for storing a longer duration of logs, as well as rich log searching and filtering capabilities. Finally, they often provide the ability to aggregate logs from multiple Pods into a single view.

Running Commands in Your Container with `exec`

Sometimes logs are insufficient, and to truly determine what's going on you need to execute commands in the context of the container itself. To do this you can use:

```
$ kubectl exec kuard date
```

You can also get an interactive session by adding the `-it` flags:

```
$ kubectl exec -it kuard ash
```

Copying Files to and from Containers

At times you may need to copy files from a remote container to a local machine for more in-depth exploration. For example, you can use a tool like Wireshark to visualize `tcpdump` packet captures. Suppose you had a file called `/captures/capture3.txt` inside a container in your Pod. You could securely copy that file to your local machine by running:

```
$ kubectl cp <pod-name>:/captures/capture3.txt ./capture3.txt
```

Other times you may need to copy files from your local machine into a container. Let's say you want to copy `$HOME/config.txt` to a remote container. In this case, you can run:

```
$ kubectl cp $HOME/config.txt <pod-name>:/config.txt
```

Generally speaking, copying files into a container is an anti-pattern. You really should treat the contents of a container as immutable. But occasionally it's the most immediate way to stop the bleeding and restore your service to health, since it is quicker than building, pushing, and rolling out a new image. Once the bleeding is stopped, however, it is critically important that you immediately go and do the image build and rollout, or you are guaranteed to forget the local change that you made to your container and overwrite it in the subsequent regularly scheduled rollout.

Health Checks

When you run your application as a container in Kubernetes, it is automatically kept alive for you using a *process health check*. This health check simply ensures that the main process of your application is always running. If it isn't, Kubernetes restarts it.

However, in most cases, a simple process check is insufficient. For example, if your process has deadlocked and is unable to serve requests, a process health check will still believe that your application is healthy since its process is still running.

To address this, Kubernetes introduced health checks for application *liveness*. Liveness health checks run application-specific logic (e.g., loading a web page) to verify that the application is not just still running, but is functioning properly. Since these liveness health checks are application-specific, you have to define them in your Pod manifest.

Liveness Probe

Once the kuard process is up and running, we need a way to confirm that it is actually healthy and shouldn't be restarted. Liveness probes are defined per container, which means each container inside a Pod is health-checked separately. In [Example 5-2](#), we add a liveness probe to our kuard container, which runs an HTTP request against the `/healthy` path on our container.

Example 5-2. kuard-pod-health.yaml

```
apiVersion: v1
kind: Pod
metadata:
  name: kuard
spec:
  containers:
    - image: gcr.io/kuar-demo/kuard-amd64:blue
      name: kuard
      livenessProbe:
        httpGet:
          path: /healthy
          port: 8080
        initialDelaySeconds: 5
        timeoutSeconds: 1
        periodSeconds: 10
        failureThreshold: 3
      ports:
        - containerPort: 8080
          name: http
          protocol: TCP
```

The preceding Pod manifest uses an `HttpGet` probe to perform an HTTP GET request against the `/healthy` endpoint on port 8080 of the `kuard` container. The probe sets an `initialDelaySeconds` of 5, and thus will not be called until 5 seconds after all the containers in the Pod are created. The probe must respond within the 1-second timeout, and the HTTP status code must be equal to or greater than 200 and less than 400 to be considered successful. Kubernetes will call the probe every 10 seconds. If more than three consecutive probes fail, the container will fail and restart.

You can see this in action by looking at the `kuard` status page. Create a Pod using this manifest and then port-forward to that Pod:

```
$ kubectl apply -f kuard-pod-health.yaml
$ kubectl port-forward kuard 8080:8080
```

Point your browser to <http://localhost:8080>. Click the “Liveness Probe” tab. You should see a table that lists all of the probes that this instance of `kuard` has received. If you click the “Fail” link on that page, `kuard` will start to fail health checks. Wait long enough and Kubernetes will restart the container. At that point the display will reset and start over again. Details of the restart can be found with `kubectl describe pods kuard`. The “Events” section will have text similar to the following:

```
Killing container with id docker://2ac946...:pod "kuard_default(9ee84...)"
container "kuard" is unhealthy, it will be killed and re-created.
```



While the default response to a failed liveness check is to restart the Pod, the actual behavior is governed by the Pod’s `restartPolicy`. There are three options for the restart policy: `Always` (the default), `OnFailure` (restart only on liveness failure or nonzero process exit code), or `Never`.

Readiness Probe

Of course, liveness isn’t the only kind of health check we want to perform. Kubernetes makes a distinction between *liveness* and *readiness*. Liveness determines if an application is running properly. Containers that fail liveness checks are restarted. Readiness describes when a container is ready to serve user requests. Containers that fail readiness checks are removed from service load balancers. Readiness probes are configured similarly to liveness probes. We explore Kubernetes services in detail in [Chapter 7](#).

Combining the readiness and liveness probes helps ensure only healthy containers are running within the cluster.

Types of Health Checks

In addition to HTTP checks, Kubernetes also supports `tcpSocket` health checks that open a TCP socket; if the connection is successful, the probe succeeds. This style of probe is useful for non-HTTP applications; for example, databases or other non-HTTP-based APIs.

Finally, Kubernetes allows `exec` probes. These execute a script or program in the context of the container. Following typical convention, if this script returns a zero exit code, the probe succeeds; otherwise, it fails. `exec` scripts are often useful for custom application validation logic that doesn't fit neatly into an HTTP call.

Resource Management

Most people move into containers and orchestrators like Kubernetes because of the radical improvements in image packaging and reliable deployment they provide. In addition to application-oriented primitives that simplify distributed system development, equally important is the ability to increase the overall utilization of the compute nodes that make up the cluster. The basic cost of operating a machine, either virtual or physical, is basically constant regardless of whether it is idle or fully loaded. Consequently, ensuring that these machines are maximally active increases the efficiency of every dollar spent on infrastructure.

Generally speaking, we measure this efficiency with the *utilization* metric. Utilization is defined as the amount of a resource actively being used divided by the amount of a resource that has been purchased. For example, if you purchase a one-core machine, and your application uses one-tenth of a core, then your utilization is 10%.

With scheduling systems like Kubernetes managing resource packing, you can drive your utilization to greater than 50%.

To achieve this, you have to tell Kubernetes about the resources your application requires, so that Kubernetes can find the optimal packing of containers onto purchased machines.

Kubernetes allows users to specify two different resource metrics. Resource *requests* specify the minimum amount of a resource required to run the application. Resource *limits* specify the maximum amount of a resource that an application can consume. Both of these resource definitions are described in greater detail in the following sections.

Resource Requests: Minimum Required Resources

With Kubernetes, a Pod requests the resources required to run its containers. Kubernetes guarantees that these resources are available to the Pod. The most commonly

requested resources are CPU and memory, but Kubernetes has support for other resource types as well, such as GPUs and more.

For example, to request that the `kuard` container lands on a machine with half a CPU free and gets 128 MB of memory allocated to it, we define the Pod as shown in [Example 5-3](#).

Example 5-3. `kuard-pod-resreq.yaml`

```
apiVersion: v1
kind: Pod
metadata:
  name: kuard
spec:
  containers:
  - image: gcr.io/kuar-demo/kuard-amd64:blue
    name: kuard
    resources:
      requests:
        cpu: "500m"
        memory: "128Mi"
    ports:
    - containerPort: 8080
      name: http
      protocol: TCP
```



Resources are requested per container, not per Pod. The total resources requested by the Pod is the sum of all resources requested by all containers in the Pod. The reason for this is that in many cases the different containers have very different CPU requirements. For example, in the web server and data synchronizer Pod, the web server is user-facing and likely needs a great deal of CPU, while the data synchronizer can make do with very little.

Request limit details

Requests are used when scheduling Pods to nodes. The Kubernetes scheduler will ensure that the sum of all requests of all Pods on a node does not exceed the capacity of the node. Therefore, a Pod is guaranteed to have at least the requested resources when running on the node. Importantly, “request” specifies a minimum. It does not specify a maximum cap on the resources a Pod may use. To explore what this means, let’s look at an example.

Imagine that we have container whose code attempts to use all available CPU cores. Suppose that we create a Pod with this container that requests 0.5 CPU. Kubernetes schedules this Pod onto a machine with a total of 2 CPU cores.

As long as it is the only Pod on the machine, it will consume all 2.0 of the available cores, despite only requesting 0.5 CPU.

If a second Pod with the same container and the same request of 0.5 CPU lands on the machine, then each Pod will receive 1.0 cores.

If a third identical Pod is scheduled, each Pod will receive 0.66 cores. Finally, if a fourth identical Pod is scheduled, each Pod will receive the 0.5 core it requested, and the node will be at capacity.

CPU requests are implemented using the `cpu-shares` functionality in the Linux kernel.



Memory requests are handled similarly to CPU, but there is an important difference. If a container is over its memory request, the OS can't just remove memory from the process, because it's been allocated. Consequently, when the system runs out of memory, the kubelet terminates containers whose memory usage is greater than their requested memory. These containers are automatically restarted, but with less available memory on the machine for the container to consume.

Since resource requests guarantee resource availability to a Pod, they are critical to ensuring that containers have sufficient resources in high-load situations.

Capping Resource Usage with Limits

In addition to setting the resources required by a Pod, which establishes the minimum resources available to the Pod, you can also set a maximum on a Pod's resource usage via resource *limits*.

In our previous example we created a `kuard` Pod that requested a minimum of 0.5 of a core and 128 MB of memory. In the Pod manifest in [Example 5-4](#), we extend this configuration to add a limit of 1.0 CPU and 256 MB of memory.

Example 5-4. `kuard-pod-reslim.yaml`

```
apiVersion: v1
kind: Pod
metadata:
  name: kuard
spec:
  containers:
  - image: gcr.io/kuar-demo/kuard-amd64:blue
    name: kuard
    resources:
      requests:
```

```
    cpu: "500m"
    memory: "128Mi"
  limits:
    cpu: "1000m"
    memory: "256Mi"
  ports:
  - containerPort: 8080
    name: http
    protocol: TCP
```

When you establish limits on a container, the kernel is configured to ensure that consumption cannot exceed these limits. A container with a CPU limit of 0.5 cores will only ever get 0.5 cores, even if the CPU is otherwise idle. A container with a memory limit of 256 MB will not be allowed additional memory (e.g., `malloc` will fail) if its memory usage exceeds 256 MB.

Persisting Data with Volumes

When a Pod is deleted or a container restarts, any and all data in the container's filesystem is also deleted. This is often a good thing, since you don't want to leave around cruft that happened to be written by your stateless web application. In other cases, having access to persistent disk storage is an important part of a healthy application. Kubernetes models such persistent storage.

Using Volumes with Pods

To add a volume to a Pod manifest, there are two new stanzas to add to our configuration. The first is a new `spec.volumes` section. This array defines all of the volumes that may be accessed by containers in the Pod manifest. It's important to note that not all containers are required to mount all volumes defined in the Pod. The second addition is the `volumeMounts` array in the container definition. This array defines the volumes that are mounted into a particular container, and the path where each volume should be mounted. Note that two different containers in a Pod can mount the same volume at different mount paths.

The manifest in [Example 5-5](#) defines a single new volume named `kuard-data`, which the `kuard` container mounts to the `/data` path.

Example 5-5. `kuard-pod-vol.yaml`

```
apiVersion: v1
kind: Pod
metadata:
  name: kuard
spec:
  volumes:
```



```

- name: "kuard-data"
  hostPath:
    path: "/var/lib/kuard"
containers:
- image: gcr.io/kuar-demo/kuard-amd64:blue
  name: kuard
  volumeMounts:
  - mountPath: "/data"
    name: "kuard-data"
  ports:
  - containerPort: 8080
    name: http
    protocol: TCP

```

Different Ways of Using Volumes with Pods

There are a variety of ways you can use data in your application. The following are a few, and the recommended patterns for Kubernetes.

Communication/synchronization

In the first example of a Pod, we saw how two containers used a shared volume to serve a site while keeping it synchronized to a remote Git location. To achieve this, the Pod uses an `emptyDir` volume. Such a volume is scoped to the Pod's lifespan, but it can be shared between two containers, forming the basis for communication between our Git sync and web serving containers.

Cache

An application may use a volume that is valuable for performance, but not required for correct operation of the application. For example, perhaps the application keeps prerendered thumbnails of larger images. Of course, they can be reconstructed from the original images, but that makes serving the thumbnails more expensive. You want such a cache to survive a container restart due to a health-check failure, and thus `emptyDir` works well for the cache use case as well.

Persistent data

Sometimes you will use a volume for truly persistent data—data that is independent of the lifespan of a particular Pod, and should move between nodes in the cluster if a node fails or a Pod moves to a different machine for some reason. To achieve this, Kubernetes supports a wide variety of remote network storage volumes, including widely supported protocols like NFS and iSCSI as well as cloud provider network storage like Amazon's Elastic Block Store, Azure's Files and Disk Storage, as well as Google's Persistent Disk.

Mounting the host filesystem

Other applications don't actually need a persistent volume, but they do need some access to the underlying host filesystem. For example, they may need access to the `/dev` filesystem in order to perform raw block-level access to a device on the system. For these cases, Kubernetes supports the `hostPath` volume, which can mount arbitrary locations on the worker node into the container.

The previous example uses the `hostPath` volume type. The volume created is `/var/lib/kuard` on the host.

Persisting Data Using Remote Disks

Oftentimes, you want the data a Pod is using to stay with the Pod, even if it is restarted on a different host machine.

To achieve this, you can mount a remote network storage volume into your Pod. When using network-based storage, Kubernetes automatically mounts and unmounts the appropriate storage whenever a Pod using that volume is scheduled onto a particular machine.

There are numerous methods for mounting volumes over the network. Kubernetes includes support for standard protocols such as NFS and iSCSI as well as cloud provider-based storage APIs for the major cloud providers (both public and private). In many cases, the cloud providers will also create the disk for you if it doesn't already exist.

Here is an example of using an NFS server:

```
...
# Rest of pod definition above here
volumes:
  - name: "kuard-data"
    nfs:
      server: my.nfs.server.local
      path: "/exports"
```

Persistent volumes are a deep topic that has many different details: in particular, the manner in which persistent volumes, persistent volume claims, and dynamic volume provisioning work together. There is a more in-depth examination of the subject in [Chapter 15](#).

Putting It All Together

Many applications are stateful, and as such we must preserve any data and ensure access to the underlying storage volume regardless of what machine the application runs on. As we saw earlier, this can be achieved using a persistent volume backed by network-attached storage. We also want to ensure that a healthy instance of the

application is running at all times, which means we want to make sure the container running kuard is ready before we expose it to clients.

Through a combination of persistent volumes, readiness and liveness probes, and resource restrictions, Kubernetes provides everything needed to run stateful applications reliably. [Example 5-6](#) pulls this all together into one manifest.

Example 5-6. kuard-pod-full.yaml

```
apiVersion: v1
kind: Pod
metadata:
  name: kuard
spec:
  volumes:
    - name: "kuard-data"
      nfs:
        server: my.nfs.server.local
        path: "/exports"
  containers:
    - image: gcr.io/kuar-demo/kuard-amd64:blue
      name: kuard
      ports:
        - containerPort: 8080
          name: http
          protocol: TCP
      resources:
        requests:
          cpu: "500m"
          memory: "128Mi"
        limits:
          cpu: "1000m"
          memory: "256Mi"
      volumeMounts:
        - mountPath: "/data"
          name: "kuard-data"
      livenessProbe:
        httpGet:
          path: /healthy
          port: 8080
        initialDelaySeconds: 5
        timeoutSeconds: 1
        periodSeconds: 10
        failureThreshold: 3
      readinessProbe:
        httpGet:
          path: /ready
          port: 8080
        initialDelaySeconds: 30
        timeoutSeconds: 1
```

```
periodSeconds: 10  
failureThreshold: 3
```

Summary

Pods represent the atomic unit of work in a Kubernetes cluster. Pods are comprised of one or more containers working together symbiotically. To create a Pod, you write a Pod manifest and submit it to the Kubernetes API server by using the command-line tool or (less frequently) by making HTTP and JSON calls to the server directly.

Once you've submitted the manifest to the API server, the Kubernetes scheduler finds a machine where the Pod can fit and schedules the Pod to that machine. Once scheduled, the kubelet daemon on that machine is responsible for creating the containers that correspond to the Pod, as well as performing any health checks defined in the Pod manifest.

Once a Pod is scheduled to a node, no rescheduling occurs if that node fails. Additionally, to create multiple replicas of the same Pod you have to create and name them manually. In a later chapter we introduce the ReplicaSet object and show how you can automate the creation of multiple identical Pods and ensure that they are recreated in the event of a node machine failure.

Labels and Annotations

Kubernetes was made to grow with you as your application scales in both size and complexity. With this in mind, labels and annotations were added as foundational concepts. Labels and annotations let you work in sets of things that map to how *you* think about your application. You can organize, mark, and cross-index all of your resources to represent the groups that make the most sense for your application.

Labels are key/value pairs that can be attached to Kubernetes objects such as Pods and ReplicaSets. They can be arbitrary, and are useful for attaching identifying information to Kubernetes objects. Labels provide the foundation for grouping objects.

Annotations, on the other hand, provide a storage mechanism that resembles labels: annotations are key/value pairs designed to hold nonidentifying information that can be leveraged by tools and libraries.

Labels

Labels provide identifying metadata for objects. These are fundamental qualities of the object that will be used for grouping, viewing, and operating.



The motivations for labels grew out of Google's experience in running large and complex applications. There were a couple of lessons that emerged from this experience. See the great site reliability book *Site Reliability Engineering* by Betsy Beyer et al. (O'Reilly) for some deeper background on how Google approaches production systems.

The first lesson is that production abhors a singleton. When deploying software, users will often start with a single instance. However, as the application matures, these singletons often multiply and become sets of objects. With this in mind, Kubernetes uses labels to deal with sets of objects instead of single instances.

The second lesson is that any hierarchy imposed by the system will fall short for many users. In addition, user groupings and hierarchies are subject to change over time. For instance, a user may start out with the idea that all apps are made up of many services. However, over time, a service may be shared across multiple apps. Kubernetes labels are flexible enough to adapt to these situations and more.

Labels have simple syntax. They are key/value pairs, where both the key and value are represented by strings. Label keys can be broken down into two parts: an optional prefix and a name, separated by a slash. The prefix, if specified, must be a DNS subdomain with a 253-character limit. The key name is required and must be shorter than 63 characters. Names must also start and end with an alphanumeric character and permit the use of dashes (-), underscores (_), and dots (.) between characters.

Label values are strings with a maximum length of 63 characters. The contents of the label values follow the same rules as for label keys.

Table 6-1 shows some valid label keys and values.

Table 6-1. Label examples

Key	Value
acme.com/app-version	1.0.0
appVersion	1.0.0
app.version	1.0.0
kubernetes.io/cluster-service	true

When domain names are used in labels and annotations they are expected to be aligned to that particular entity in some way. For example, a project might define a canonical set of labels used to identify the various stages of application deployment (e.g., staging, canary, production).

Or a cloud provider might define provider-specific annotations that extend Kubernetes objects to activate features specific to their service.

Applying Labels

Here we create a few deployments (a way to create an array of Pods) with some interesting labels. We'll take two apps (called `alpaca` and `bandicoot`) and have two environments for each. We will also have two different versions:

1. First, create the `alpaca-prod` deployment and set the `ver`, `app`, and `env` labels:

```
$ kubectl run alpaca-prod \
  --image=gcr.io/kuar-demo/kuard-amd64:blue \
  --replicas=2 \
  --labels="ver=1,app=alpaca,env=prod"
```

2. Next, create the `alpaca-test` deployment and set the `ver`, `app`, and `env` labels with the appropriate values:

```
$ kubectl run alpaca-test \
  --image=gcr.io/kuar-demo/kuard-amd64:green \
  --replicas=1 \
  --labels="ver=2,app=alpaca,env=test"
```

3. Finally, create two deployments for `bandicoot`. Here we name the environments `prod` and `staging`:

```
$ kubectl run bandicoot-prod \
  --image=gcr.io/kuar-demo/kuard-amd64:green \
  --replicas=2 \
  --labels="ver=2,app=bandicoot,env=prod"
$ kubectl run bandicoot-staging \
  --image=gcr.io/kuar-demo/kuard-amd64:green \
  --replicas=1 \
  --labels="ver=2,app=bandicoot,env=staging"
```

At this point you should have four deployments—`alpaca-prod`, `alpaca-test`, `bandicoot-prod`, and `bandicoot-staging`:

```
$ kubectl get deployments --show-labels

NAME                ... LABELS
alpaca-prod         ... app=alpaca,env=prod,ver=1
alpaca-test         ... app=alpaca,env=test,ver=2
bandicoot-prod      ... app=bandicoot,env=prod,ver=2
bandicoot-staging   ... app=bandicoot,env=staging,ver=2
```

We can visualize this as a Venn diagram based on the labels (Figure 6-1).

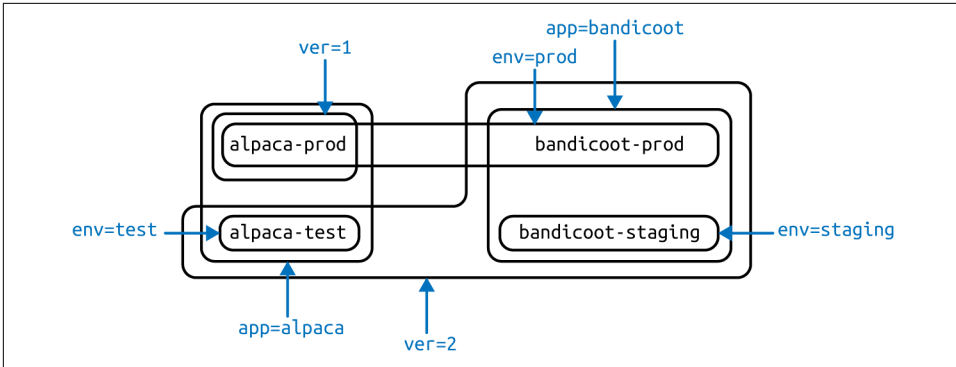

Figure 6-1. Visualization of labels applied to our deployments

Modifying Labels

Labels can also be applied (or updated) on objects after they are created:

```
$ kubectl label deployments alpaca-test "canary=true"
```



There is a caveat to be aware of here. In this example, the `kubectl label` command will only change the label on the deployment itself; it won't affect the objects (ReplicaSets and Pods) the deployment creates. To change those, you'll need to change the template embedded in the deployment (see [Chapter 10](#)).

You can also use the `-L` option to `kubectl get` to show a label value as a column:

```
$ kubectl get deployments -L canary
```

NAME	DESIRED	CURRENT	... CANARY
alpaca-prod	2	2	... <none>
alpaca-test	1	1	... true
bandicoot-prod	2	2	... <none>
bandicoot-staging	1	1	... <none>

You can remove a label by applying a dash suffix:

```
$ kubectl label deployments alpaca-test "canary-"
```

Label Selectors

Label selectors are used to filter Kubernetes objects based on a set of labels. Selectors use a simple Boolean language. They are used both by end users (via tools like `kubectl`) and by different types of objects (such as how a ReplicaSet relates to its Pods).

Each deployment (via a ReplicaSet) creates a set of Pods using the labels specified in the template embedded in the deployment. This is configured by the `kubectl run` command.

Running the `kubectl get pods` command should return all the Pods currently running in the cluster. We should have a total of six `kuard` Pods across our three environments:

```
$ kubectl get pods --show-labels
```

```
NAME                                     ... LABELS
alpaca-prod-3408831585-4nzfb           ... app=alpaca,env=prod,ver=1,...
alpaca-prod-3408831585-kgaoa           ... app=alpaca,env=prod,ver=1,...
alpaca-test-1004512375-3r1m5           ... app=alpaca,env=test,ver=2,...
bandicoot-prod-373860099-0t1gp         ... app=bandicoot,env=prod,ver=2,...
bandicoot-prod-373860099-k2wcf         ... app=bandicoot,env=prod,ver=2,...
bandicoot-staging-1839769971-3ndv      ... app=bandicoot,env=staging,ver=2,...
```



You may see a new label that we haven't seen yet: `pod-template-hash`. This label is applied by the deployment so it can keep track of which Pods were generated from which template versions. This allows the deployment to manage updates in a clean way, as will be covered in depth in [Chapter 10](#).

If we only wanted to list Pods that had the `ver` label set to 2, we could use the `--selector` flag:

```
$ kubectl get pods --selector="ver=2"
```

```
NAME                                     READY   STATUS    RESTARTS   AGE
alpaca-test-1004512375-3r1m5           1/1     Running   0           3m
bandicoot-prod-373860099-0t1gp         1/1     Running   0           3m
bandicoot-prod-373860099-k2wcf         1/1     Running   0           3m
bandicoot-staging-1839769971-3ndv5     1/1     Running   0           3m
```

If we specify two selectors separated by a comma, only the objects that satisfy both will be returned. This is a logical AND operation:

```
$ kubectl get pods --selector="app=bandicoot,ver=2"
```

```
NAME                                     READY   STATUS    RESTARTS   AGE
bandicoot-prod-373860099-0t1gp         1/1     Running   0           4m
bandicoot-prod-373860099-k2wcf         1/1     Running   0           4m
bandicoot-staging-1839769971-3ndv5     1/1     Running   0           4m
```

We can also ask if a label is one of a set of values. Here we ask for all Pods where the `app` label is set to `alpaca` or `bandicoot` (which will be all six Pods):

```
$ kubectl get pods --selector="app in (alpaca,bandicoot)"
```

NAME	READY	STATUS	RESTARTS	AGE
alpaca-prod-3408831585-4nzfb	1/1	Running	0	6m
alpaca-prod-3408831585-kga0a	1/1	Running	0	6m
alpaca-test-1004512375-3r1m5	1/1	Running	0	6m
bandicoot-prod-373860099-0t1gp	1/1	Running	0	6m
bandicoot-prod-373860099-k2wcf	1/1	Running	0	6m
bandicoot-staging-1839769971-3ndv5	1/1	Running	0	6m

Finally, we can ask if a label is set at all. Here we are asking for all of the deployments with the canary label set to anything:

```
$ kubectl get deployments --selector="canary"
```

NAME	DESIRED	CURRENT	UP-TO-DATE	AVAILABLE	AGE
alpaca-test	1	1	1	1	7m

There are also “negative” versions of each of these, as shown in [Table 6-2](#).

Table 6-2. Selector operators

Operator	Description
key=value	key is set to value
key!=value	key is not set to value
key in (value1, value2)	key is one of value1 or value2
key notin (value1, value2)	key is not one of value1 or value2
key	key is set
!key	key is not set

For example, asking if a key, in this case canary, is not set can look like:

```
$ kubectl get deployments --selector='!canary'
```

Similarly, you can combine positive and negative selectors together as follows:

```
$ kubectl get pods -l 'ver=2,!canary'
```

Label Selectors in API Objects

When a Kubernetes object refers to a set of other Kubernetes objects, a label selector is used. Instead of a simple string as described in the previous section, we use a parsed structure.

For historical reasons (Kubernetes doesn’t break API compatibility!), there are two forms. Most objects support a newer, more powerful set of selector operators.

A selector of `app=alpaca,ver in (1, 2)` would be converted to this:

```
selector:
  matchLabels:
    app: alpaca
```

```
matchExpressions:
- {key: ver, operator: In, values: [1, 2]} ❶
```

- ❶ Compact YAML syntax. This is an item in a list (`matchExpressions`) that is a map with three entries. The last entry (`values`) has a value that is a list with two items.

All of the terms are evaluated as a logical AND. The only way to represent the `!=` operator is to convert it to a `NotIn` expression with a single value.

The older form of specifying selectors (used in `ReplicationControllers` and `services`) only supports the `=` operator. This is a simple set of key/value pairs that must all match a target object to be selected.

The selector `app=alpaca,ver=1` would be represented like this:

```
selector:
  app: alpaca
  ver: 1
```

Labels in the Kubernetes Architecture

In addition to enabling users to organize their infrastructure, labels play a critical role in linking various related Kubernetes objects. Kubernetes is a purposefully decoupled system. There is no hierarchy and all components operate independently. However, in many cases objects need to relate to one another, and these relationships are defined by labels and label selectors.

For example, `ReplicaSets`, which create and maintain multiple replicas of a `Pod`, find the `Pods` that they are managing via a selector. Likewise, a service load balancer finds the `Pods` it should bring traffic to via a selector query. When a `Pod` is created, it can use a node selector to identify a particular set of nodes that it can be scheduled onto. When people want to restrict network traffic in their cluster, they use `NetworkPolicy` in conjunction with specific labels to identify `Pods` that should or should not be allowed to communicate with each other. Labels are a powerful and ubiquitous glue that holds a Kubernetes application together. Though your application will likely start out with a simple set of labels and queries, you should expect it to grow in size and sophistication with time.

Annotations

Annotations provide a place to store additional metadata for Kubernetes objects with the sole purpose of assisting tools and libraries. They are a way for other programs driving Kubernetes via an API to store some opaque data with an object. Annotations can be used for the tool itself or to pass configuration information between external systems.

While labels are used to identify and group objects, annotations are used to provide extra information about where an object came from, how to use it, or policy around that object. There is overlap, and it is a matter of taste as to when to use an annotation or a label. When in doubt, add information to an object as an annotation and promote it to a label if you find yourself wanting to use it in a selector.

Annotations are used to:

- Keep track of a “reason” for the latest update to an object.
- Communicate a specialized scheduling policy to a specialized scheduler.
- Extend data about the last tool to update the resource and how it was updated (used for detecting changes by other tools and doing a smart merge).
- Attach build, release, or image information that isn’t appropriate for labels (may include a Git hash, timestamp, PR number, etc.).
- Enable the Deployment object ([Chapter 10](#)) to keep track of ReplicaSets that it is managing for rollouts.
- Provide extra data to enhance the visual quality or usability of a UI. For example, objects could include a link to an icon (or a base64-encoded version of an icon).
- Prototype alpha functionality in Kubernetes (instead of creating a first-class API field, the parameters for that functionality are encoded in an annotation).

Annotations are used in various places in Kubernetes, with the primary use case being rolling deployments. During rolling deployments, annotations are used to track rollout status and provide the necessary information required to roll back a deployment to a previous state.

Users should avoid using the Kubernetes API server as a general-purpose database. Annotations are good for small bits of data that are highly associated with a specific resource. If you want to store data in Kubernetes but you don’t have an obvious object to associate it with, consider storing that data in some other, more appropriate database.

Defining Annotations

Annotation keys use the same format as label keys. However, because they are often used to communicate information between tools, the “namespace” part of the key is more important. Example keys include `deployment.kubernetes.io/revision` or `kubernetes.io/change-cause`.

The value component of an annotation is a free-form string field. While this allows maximum flexibility as users can store arbitrary data, because this is arbitrary text, there is no validation of any format. For example, it is not uncommon for a JSON document to be encoded as a string and stored in an annotation. It is important to

note that the Kubernetes server has no knowledge of the required format of annotation values. If annotations are used to pass or store data, there is no guarantee the data is valid. This can make tracking down errors more difficult.

Annotations are defined in the common `metadata` section in every Kubernetes object:

```
...
metadata:
  annotations:
    example.com/icon-url: "https://example.com/icon.png"
...
```



Annotations are very convenient and provide powerful loose coupling. However, they should be used judiciously to avoid an untidy mess of data.

Cleanup

It is easy to clean up all of the deployments that we started in this chapter:

```
$ kubectl delete deployments --all
```

If you want to be more selective, you can use the `--selector` flag to choose which deployments to delete.

Summary

Labels are used to identify and optionally group objects in a Kubernetes cluster. Labels are also used in selector queries to provide flexible runtime grouping of objects such as Pods.

Annotations provide object-scoped key/value storage of metadata that can be used by automation tooling and client libraries. Annotations can also be used to hold configuration data for external tools such as third-party schedulers and monitoring tools.

Labels and annotations are vital to understanding how key components in a Kubernetes cluster work together to ensure the desired cluster state. Using labels and annotations properly unlocks the true power of Kubernetes's flexibility and provides the starting point for building automation tools and deployment workflows.

Service Discovery

Kubernetes is a very dynamic system. The system is involved in placing Pods on nodes, making sure they are up and running, and rescheduling them as needed. There are ways to automatically change the number of Pods based on load (such as horizontal Pod autoscaling [see “Autoscaling a ReplicaSet” on page 110]). The API-driven nature of the system encourages others to create higher and higher levels of automation.

While the dynamic nature of Kubernetes makes it easy to run a lot of things, it creates problems when it comes to *finding* those things. Most of the traditional network infrastructure wasn’t built for the level of dynamism that Kubernetes presents.

What Is Service Discovery?

The general name for this class of problems and solutions is *service discovery*. Service-discovery tools help solve the problem of finding which processes are listening at which addresses for which services. A good service-discovery system will enable users to resolve this information quickly and reliably. A good system is also low-latency; clients are updated soon after the information associated with a service changes. Finally, a good service-discovery system can store a richer definition of what that service is. For example, perhaps there are multiple ports associated with the service.

The Domain Name System (DNS) is the traditional system of service discovery on the internet. DNS is designed for relatively stable name resolution with wide and efficient caching. It is a great system for the internet but falls short in the dynamic world of Kubernetes.

Unfortunately, many systems (for example, Java, by default) look up a name in DNS directly and never re-resolve. This can lead to clients caching stale mappings and talking to the wrong IP. Even with short TTLs and well-behaved clients, there is a

natural delay between when a name resolution changes and when the client notices. There are natural limits to the amount and type of information that can be returned in a typical DNS query, too. Things start to break past 20–30 A records for a single name. SRV records solve some problems, but are often very hard to use. Finally, the way that clients handle multiple IPs in a DNS record is usually to take the first IP address and rely on the DNS server to randomize or round-robin the order of records. This is no substitute for more purpose-built load balancing.

The Service Object

Real service discovery in Kubernetes starts with a Service object.

A Service object is a way to create a named label selector. As we will see, the Service object does some other nice things for us, too.

Just as the `kubectl run` command is an easy way to create a Kubernetes deployment, we can use `kubectl expose` to create a service. Let's create some deployments and services so we can see how they work:

```
$ kubectl run alpaca-prod \
  --image=gcr.io/kuar-demo/kuard-amd64:blue \
  --replicas=3 \
  --port=8080 \
  --labels="ver=1,app=alpaca,env=prod"
$ kubectl expose deployment alpaca-prod
$ kubectl run bandicoot-prod \
  --image=gcr.io/kuar-demo/kuard-amd64:green \
  --replicas=2 \
  --port=8080 \
  --labels="ver=2,app=bandicoot,env=prod"
$ kubectl expose deployment bandicoot-prod
$ kubectl get services -o wide
```

NAME	CLUSTER-IP	... PORT(S)	... SELECTOR
alpaca-prod	10.115.245.13	... 8080/TCP	... app=alpaca,env=prod,ver=1
bandicoot-prod	10.115.242.3	... 8080/TCP	... app=bandicoot,env=prod,ver=2
kubernetes	10.115.240.1	... 443/TCP	... <none>

After running these commands, we have three services. The ones we just created are `alpaca-prod` and `bandicoot-prod`. The `kubernetes` service is automatically created for you so that you can find and talk to the Kubernetes API from within the app.

If we look at the `SELECTOR` column, we see that the `alpaca-prod` service simply gives a name to a selector and specifies which ports to talk to for that service. The `kubectl expose` command will conveniently pull both the label selector and the relevant ports (8080, in this case) from the deployment definition.

Furthermore, that service is assigned a new type of virtual IP called a *cluster IP*. This is a special IP address the system will load-balance across all of the Pods that are identified by the selector.

To interact with services, we are going to port forward to one of the `alpaca` Pods. Start and leave this command running in a terminal window. You can see the port forward working by accessing the `alpaca` Pod at <http://localhost:48858>:

```
$ ALPACA_POD=$(kubectl get pods -l app=alpaca \
  -o jsonpath='{.items[0].metadata.name}')
$ kubectl port-forward $ALPACA_POD 48858:8080
```

Service DNS

Because the cluster IP is virtual, it is stable, and it is appropriate to give it a DNS address. All of the issues around clients caching DNS results no longer apply. Within a namespace, it is as easy as just using the service name to connect to one of the Pods identified by a service.

Kubernetes provides a DNS service exposed to Pods running in the cluster. This Kubernetes DNS service was installed as a system component when the cluster was first created. The DNS service is, itself, managed by Kubernetes and is a great example of Kubernetes building on Kubernetes. The Kubernetes DNS service provides DNS names for cluster IPs.

You can try this out by expanding the “DNS Query” section on the `kuard` server status page. Query the A record for `alpaca-prod`. The output should look something like this:

```
;; opcode: QUERY, status: NOERROR, id: 12071
;; flags: qr aa rd ra; QUERY: 1, ANSWER: 1, AUTHORITY: 0, ADDITIONAL: 0

;; QUESTION SECTION:
;alpaca-prod.default.svc.cluster.local. IN      A

;; ANSWER SECTION:
alpaca-prod.default.svc.cluster.local. 30     IN      A       10.115.245.13
```

The full DNS name here is `alpaca-prod.default.svc.cluster.local`.. Let’s break this down:

`alpaca-prod`

The name of the service in question.

`default`

The namespace that this service is in.

svc

Recognizing that this is a service. This allows Kubernetes to expose other types of things as DNS in the future.

cluster.local.

The base domain name for the cluster. This is the default and what you will see for most clusters. Administrators may change this to allow unique DNS names across multiple clusters.

When referring to a service in your own namespace you can just use the service name (alpaca-prod). You can also refer to a service in another namespace with alpaca-prod.default. And, of course, you can use the fully qualified service name (alpaca-prod.default.svc.cluster.local.). Try each of these out in the “DNS Query” section of kuard.

Readiness Checks

Often, when an application first starts up it isn’t ready to handle requests. There is usually some amount of initialization that can take anywhere from under a second to several minutes. One nice thing the Service object does is track which of your Pods are ready via a readiness check. Let’s modify our deployment to add a readiness check that is attached to a Pod, as we discussed in [Chapter 5](#):

```
$ kubectl edit deployment/alpaca-prod
```

This command will fetch the current version of the alpaca-prod deployment and bring it up in an editor. After you save and quit your editor, it’ll then write the object back to Kubernetes. This is a quick way to edit an object without saving it to a YAML file.

Add the following section:

```
spec:
  ...
  template:
    ...
    spec:
      containers:
        ...
        name: alpaca-prod
        readinessProbe:
          httpGet:
            path: /ready
            port: 8080
            periodSeconds: 2
            initialDelaySeconds: 0
            failureThreshold: 3
            successThreshold: 1
```

This sets up the Pods this deployment will create so that they will be checked for readiness via an HTTP GET to `/ready` on port 8080. This check is done every 2 seconds starting as soon as the Pod comes up. If three successive checks fail, then the Pod will be considered not ready. However, if only one check succeeds, the Pod will again be considered ready.

Only ready Pods are sent traffic.

Updating the deployment definition like this will delete and recreate the alpaca Pods. As such, we need to restart our `port-forward` command from earlier:

```
$ ALPACA_POD=$(kubectl get pods -l app=alpaca \
  -o jsonpath='{.items[0].metadata.name}')
$ kubectl port-forward $ALPACA_POD 48858:8080
```

Point your browser to <http://localhost:48858> and you should see the debug page for that instance of kuard. Expand the “Readiness Probe” section. You should see this page update every time there is a new readiness check from the system, which should happen every 2 seconds.

In another terminal window, start a `watch` command on the endpoints for the alpaca-prod service. Endpoints are a lower-level way of finding what a service is sending traffic to and are covered later in this chapter. The `--watch` option here causes the `kubectl` command to hang around and output any updates. This is an easy way to see how a Kubernetes object changes over time:

```
$ kubectl get endpoints alpaca-prod --watch
```

Now go back to your browser and hit the “Fail” link for the readiness check. You should see that the server is now returning 500s. After three of these, this server is removed from the list of endpoints for the service. Hit the “Succeed” link and notice that after a single readiness check the endpoint is added back.

This readiness check is a way for an overloaded or sick server to signal to the system that it doesn’t want to receive traffic anymore. This is a great way to implement graceful shutdown. The server can signal that it no longer wants traffic, wait until existing connections are closed, and then cleanly exit.

Press `Ctrl-C` to exit out of both the `port-forward` and `watch` commands in your terminals.

Looking Beyond the Cluster

So far, everything we’ve covered in this chapter has been about exposing services inside of a cluster. Oftentimes, the IPs for Pods are only reachable from within the cluster. At some point, we have to allow new traffic in!

The most portable way to do this is to use a feature called NodePorts, which enhance a service even further. In addition to a cluster IP, the system picks a port (or the user can specify one), and every node in the cluster then forwards traffic to that port to the service.

With this feature, if you can reach any node in the cluster you can contact a service. You use the NodePort without knowing where any of the Pods for that service are running. This can be integrated with hardware or software load balancers to expose the service further.

Try this out by modifying the `alpaca-prod` service:

```
$ kubectl edit service alpaca-prod
```

Change the `spec.type` field to `NodePort`. You can also do this when creating the service via `kubectl expose` by specifying `--type=NodePort`. The system will assign a new NodePort:

```
$ kubectl describe service alpaca-prod
```

```
Name:                alpaca-prod
Namespace:           default
Labels:              app=alpaca
                    env=prod
                    ver=1
Annotations:         <none>
Selector:             app=alpaca,env=prod,ver=1
Type:                NodePort
IP:                  10.115.245.13
Port:                <unset> 8080/TCP
NodePort:            <unset> 32711/TCP
Endpoints:           10.112.1.66:8080,10.112.2.104:8080,10.112.2.105:8080
Session Affinity:    None
No events.
```

Here we see that the system assigned port 32711 to this service. Now we can hit any of our cluster nodes on that port to access the service. If you are sitting on the same network, you can access it directly. If your cluster is in the cloud someplace, you can use SSH tunneling with something like this:

```
$ ssh <node> -L 8080:localhost:32711
```

Now if you point your browser to `http://localhost:8080` you will be connected to that service. Each request that you send to the service will be randomly directed to one of the Pods that implements the service. Reload the page a few times and you will see that you are randomly assigned to different Pods.

When you are done, exit out of the SSH session.

Cloud Integration

Finally, if you have support from the cloud that you are running on (and your cluster is configured to take advantage of it), you can use the `LoadBalancer` type. This builds on the `NodePort` type by additionally configuring the cloud to create a new load balancer and direct it at nodes in your cluster.

Edit the `alpaca-prod` service again (`kubectl edit service alpaca-prod`) and change `spec.type` to `LoadBalancer`.

If you do a `kubectl get services` right away you'll see that the `EXTERNAL-IP` column for `alpaca-prod` now says `<pending>`. Wait a bit and you should see a public address assigned by your cloud. You can look in the console for your cloud account and see the configuration work that Kubernetes did for you:

```
$ kubectl describe service alpaca-prod

Name:                alpaca-prod
Namespace:           default
Labels:              app=alpaca
                   env=prod
                   ver=1
Selector:            app=alpaca,env=prod,ver=1
Type:                LoadBalancer
IP:                 10.115.245.13
LoadBalancer Ingress: 104.196.248.204
Port:                <unset> 8080/TCP
NodePort:            <unset> 32711/TCP
Endpoints:           10.112.1.66:8080,10.112.2.104:8080,10.112.2.105:8080
Session Affinity:    None
Events:
  FirstSeen    ... Reason          Message
  -----    ... -----
  3m           ... Type              NodePort -> LoadBalancer
  3m           ... CreatingLoadBalancer Creating load balancer
  2m           ... CreatedLoadBalancer Created load balancer
```

Here we see that we have an address of `104.196.248.204` now assigned to the `alpaca-prod` service. Open up your browser and try!



This example is from a cluster launched and managed on the Google Cloud Platform via GKE. However, the way a load balancer is configured is specific to a cloud. In addition, some clouds have DNS-based load balancers (e.g., AWS ELB). In this case you'll see a hostname here instead of an IP. Also, depending on the cloud provider, it may still take a little while for the load balancer to be fully operational.

Creating a cloud-based load balancer can take some time. Don't be surprised if it takes a few minutes on most cloud providers.

Advanced Details

Kubernetes is built to be an extensible system. As such, there are layers that allow for more advanced integrations. Understanding the details of how a sophisticated concept like services is implemented may help you troubleshoot or create more advanced integrations. This section goes a bit below the surface.

Endpoints

Some applications (and the system itself) want to be able to use services without using a cluster IP. This is done with another type of object called an Endpoints object. For every Service object, Kubernetes creates a buddy Endpoints object that contains the IP addresses for that service:

```
$ kubectl describe endpoints alpaca-prod
```

```
Name:          alpaca-prod
Namespace:     default
Labels:        app=alpaca
                env=prod
                ver=1

Subsets:
  Addresses:          10.112.1.54,10.112.2.84,10.112.2.85
  NotReadyAddresses: <none>
  Ports:
    Name      Port      Protocol
    ----      -
    <unset>   8080     TCP
```

```
No events.
```

To use a service, an advanced application can talk to the Kubernetes API directly to look up endpoints and call them. The Kubernetes API even has the capability to “watch” objects and be notified as soon as they change. In this way, a client can react immediately as soon as the IPs associated with a service change.

Let's demonstrate this. In a terminal window, start the following command and leave it running:

```
$ kubectl get endpoints alpaca-prod --watch
```

It will output the current state of the endpoint and then “hang”:

```
NAME          ENDPOINTS                                     AGE
alpaca-prod   10.112.1.54:8080,10.112.2.84:8080,10.112.2.85:8080 1m
```

Now open up *another* terminal window and delete and recreate the deployment backing `alpaca-prod`:

```
$ kubectl delete deployment alpaca-prod
$ kubectl run alpaca-prod \
  --image=gcr.io/kuar-demo/kuard-amd64:blue \
  --replicas=3 \
  --port=8080 \
  --labels="ver=1,app=alpaca,env=prod"
```

If you look back at the output from the watched endpoint, you will see that as you deleted and re-created these Pods, the output of the command reflected the most up-to-date set of IP addresses associated with the service. Your output will look something like this:

NAME	ENDPOINTS	AGE
alpaca-prod	10.112.1.54:8080,10.112.2.84:8080,10.112.2.85:8080	1m
alpaca-prod	10.112.1.54:8080,10.112.2.84:8080	1m
alpaca-prod	<none>	1m
alpaca-prod	10.112.2.90:8080	1m
alpaca-prod	10.112.1.57:8080,10.112.2.90:8080	1m
alpaca-prod	10.112.0.28:8080,10.112.1.57:8080,10.112.2.90:8080	1m

The Endpoints object is great if you are writing new code that is built to run on Kubernetes from the start. But most projects aren't in this position! Most existing systems are built to work with regular old IP addresses that don't change that often.

Manual Service Discovery

Kubernetes services are built on top of label selectors over Pods. That means that you can use the Kubernetes API to do rudimentary service discovery without using a Service object at all! Let's demonstrate.

With `kubectl` (and via the API) we can easily see what IPs are assigned to each Pod in our example deployments:

```
$ kubectl get pods -o wide --show-labels
```

NAME	... IP	... LABELS
alpaca-prod-12334-87f8h	... 10.112.1.54	... app=alpaca,env=prod,ver=1
alpaca-prod-12334-jssmh	... 10.112.2.84	... app=alpaca,env=prod,ver=1
alpaca-prod-12334-tjps6	... 10.112.2.85	... app=alpaca,env=prod,ver=1
bandicoot-prod-5678-sbxz1	... 10.112.1.55	... app=bandicoot,env=prod,ver=2
bandicoot-prod-5678-x0dh8	... 10.112.2.86	... app=bandicoot,env=prod,ver=2

This is great, but what if you have a ton of Pods? You'll probably want to filter this based on the labels applied as part of the deployment. Let's do that for just the `alpaca` app:

```
$ kubectl get pods -o wide --selector=app=alpaca,env=prod
```

```
NAME                               ... IP           ...
alpaca-prod-3408831585-bpzdz      ... 10.112.1.54    ...
alpaca-prod-3408831585-kncwt      ... 10.112.2.84    ...
alpaca-prod-3408831585-l9fsq      ... 10.112.2.85    ...
```

At this point you have the basics of service discovery! You can always use labels to identify the set of Pods you are interested in, get all of the Pods for those labels, and dig out the IP address. But keeping the correct set of labels to use in sync can be tricky. This is why the Service object was created.

kube-proxy and Cluster IPs

Cluster IPs are stable virtual IPs that load-balance traffic across all of the endpoints in a service. This magic is performed by a component running on every node in the cluster called the kube-proxy (Figure 7-1).

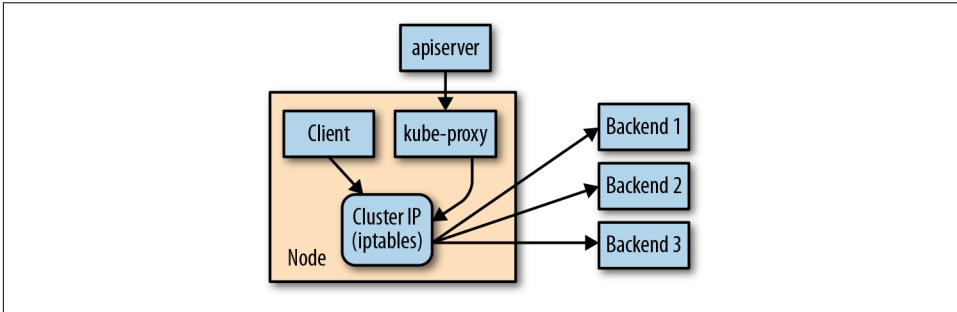

Figure 7-1. Configuring and using a cluster IP

In Figure 7-1, the kube-proxy watches for new services in the cluster via the API server. It then programs a set of `iptables` rules in the kernel of that host to rewrite the destinations of packets so they are directed at one of the endpoints for that service. If the set of endpoints for a service changes (due to Pods coming and going or due to a failed readiness check), the set of `iptables` rules is rewritten.

The cluster IP itself is usually assigned by the API server as the service is created. However, when creating the service, the user can specify a specific cluster IP. Once set, the cluster IP cannot be modified without deleting and recreating the Service object.



The Kubernetes service address range is configured using the `--service-cluster-ip-range` flag on the `kube-apiserver` binary. The service address range should not overlap with the IP subnets and ranges assigned to each Docker bridge or Kubernetes node.

In addition, any explicit cluster IP requested must come from that range and not already be in use.

Cluster IP Environment Variables

While most users should be using the DNS services to find cluster IPs, there are some older mechanisms that may still be in use. One of these is injecting a set of environment variables into Pods as they start up.

To see this in action, let's look at the console for the `bandicoot` instance of `kuard`. Enter the following commands in your terminal:

```
$ BANDICOOT_POD=$(kubectl get pods -l app=bandicoot \
  -o jsonpath='{.items[0].metadata.name}')
$ kubectl port-forward $BANDICOOT_POD 48858:8080
```

Now point your browser to `http://localhost:48858` to see the status page for this server. Expand the “Server Env” section and note the set of environment variables for the `alpaca` service. The status page should show a table similar to [Table 7-1](#).

Table 7-1. Service environment variables

Key	Value
<code>ALPACA_PROD_PORT</code>	<code>tcp://10.115.245.13:8080</code>
<code>ALPACA_PROD_PORT_8080_TCP</code>	<code>tcp://10.115.245.13:8080</code>
<code>ALPACA_PROD_PORT_8080_TCP_ADDR</code>	<code>10.115.245.13</code>
<code>ALPACA_PROD_PORT_8080_TCP_PORT</code>	<code>8080</code>
<code>ALPACA_PROD_PORT_8080_TCP_PROTO</code>	<code>tcp</code>
<code>ALPACA_PROD_SERVICE_HOST</code>	<code>10.115.245.13</code>
<code>ALPACA_PROD_SERVICE_PORT</code>	<code>8080</code>

The two main environment variables to use are `ALPACA_PROD_SERVICE_HOST` and `ALPACA_PROD_SERVICE_PORT`. The other environment variables are created to be compatible with (now deprecated) Docker link variables.

A problem with the environment variable approach is that it requires resources to be created in a specific order. The services must be created before the Pods that reference them. This can introduce quite a bit of complexity when deploying a set of services that make up a larger application. In addition, using *just* environment variables seems strange to many users. For this reason, DNS is probably a better option.

Connecting with Other Environments

While it is great to have service discovery within your own cluster, many real-world applications actually require that you integrate more cloud-native applications deployed in Kubernetes with applications deployed to more legacy environments. Additionally, you may need to integrate a Kubernetes cluster in the cloud with infrastructure that has been deployed on-premise.

This is an area of Kubernetes that is still undergoing a fair amount of exploration and development of solutions. When you are connecting Kubernetes to legacy resources outside of the cluster, you can use selector-less services to declare a Kubernetes service with a manually assigned IP address that is outside of the cluster. That way, Kubernetes service discovery via DNS works as expected, but the network traffic itself flows to an external resource.

Connecting external resources to Kubernetes services is somewhat trickier. If your cloud provider supports it, the easiest thing to do is to create an “internal” load balancer that lives in your virtual private network and can deliver traffic from a fixed IP address into the cluster. You can then use traditional DNS to make this IP address available to the external resource. Another option is to run the full kube-proxy on an external resource and program that machine to use the DNS server in the Kubernetes cluster. Such a setup is significantly more difficult to get right and should really only be used in on-premise environments. There are also a variety of open source projects (for example, Hashicorp’s Consul) that can be used to manage connectivity between in-cluster and out-of-cluster resources.

Cleanup

Run the following command to clean up all of the objects created in this chapter:

```
$ kubectl delete services,deployments -l app
```

Summary

Kubernetes is a dynamic system that challenges traditional methods of naming and connecting services over the network. The Service object provides a flexible and powerful way to expose services both within the cluster and beyond. With the techniques covered here you can connect services to each other and expose them outside the cluster.

While using the dynamic service discovery mechanisms in Kubernetes introduces some new concepts and may, at first, seem complex, understanding and adapting these techniques is key to unlocking the power of Kubernetes. Once your application can dynamically find services and react to the dynamic placement of those applications, you are free to stop worrying about where things are running and when they move. It is a critical piece of the puzzle to start to think about services in a logical way and let Kubernetes take care of the details of container placement.

HTTP Load Balancing with Ingress

A critical part of any application is getting network traffic to and from that application. As described in [Chapter 7](#), Kubernetes has a set of capabilities to enable services to be exposed outside of the cluster. For many users and simple use cases these capabilities are sufficient.

But the Service object operates at Layer 4 (according to the OSI model¹). This means that it only forwards TCP and UDP connections and doesn't look inside of those connections. Because of this, hosting many applications on a cluster uses many different exposed services. In the case where these services are `type: NodePort`, you'll have to have clients connect to a unique port per service. In the case where these services are `type: LoadBalancer`, you'll be allocating (often expensive or scarce) cloud resources for each service. But for HTTP (Layer 7)-based services, we can do better.

When solving a similar problem in non-Kubernetes situations, users often turn to the idea of “virtual hosting.” This is a mechanism to host many HTTP sites on a single IP address. Typically, the user uses a load balancer or reverse proxy to accept incoming connections on HTTP (80) and HTTPS (443) ports. That program then parses the HTTP connection and, based on the `Host` header and the URL path that is requested, proxies the HTTP call to some other program. In this way, that load balancer or reverse proxy plays “traffic cop” for decoding and directing incoming connections to the right “upstream” server.

Kubernetes calls its HTTP-based load-balancing system *Ingress*. Ingress is a Kubernetes-native way to implement the “virtual hosting” pattern we just discussed. One of the more complex aspects of the pattern is that the user has to manage the

¹ The [Open Systems Interconnection \(OSI\) model](#) is a standard way to describe how different networking layers build on each other. TCP and UDP are considered to be Layer 4, while HTTP is Layer 7.

load balancer configuration file. In a dynamic environment and as the set of virtual hosts expands, this can be very complex. The Kubernetes Ingress system works to simplify this by (a) standardizing that configuration, (b) moving it to a standard Kubernetes object, and (c) merging multiple Ingress objects into a single config for the load balancer.

The typical software base implementation looks something like what is depicted in [Figure 8-1](#). The Ingress controller is a software system exposed outside the cluster using a service of type: `LoadBalancer`. It then proxies requests to “upstream” servers. The configuration for how it does this is the result of reading and monitoring Ingress objects.

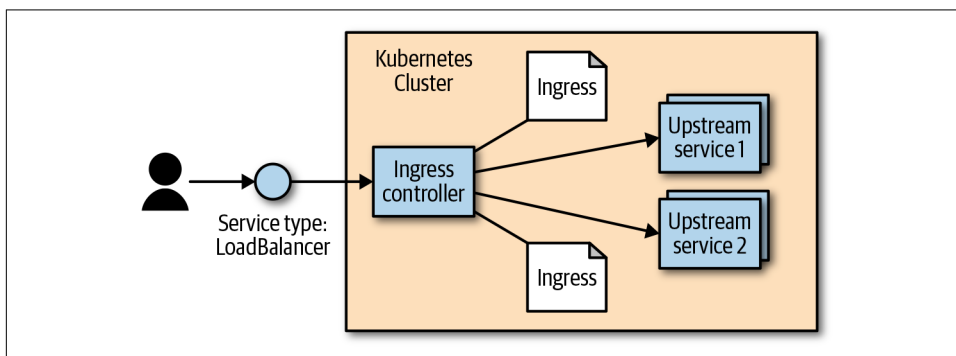

Figure 8-1. The typical software Ingress controller configuration

Ingress Spec Versus Ingress Controllers

While conceptually simple, at an implementation level Ingress is very different from pretty much every other regular resource object in Kubernetes. Specifically, it is split into a common resource specification and a controller implementation. There is no “standard” Ingress controller that is built into Kubernetes, so the user must install one of many optional implementations.

Users can create and modify Ingress objects just like every other object. But, by default, there is no code running to actually act on those objects. It is up to the users (or the distribution they are using) to install and manage an outside controller. In this way, the controller is pluggable.

There are multiple reasons that Ingress ended up like this. First of all, there is no one single HTTP load balancer that can universally be used. In addition to many software load balancers (both open source and proprietary), there are also load-balancing capabilities provided by cloud providers (e.g., ELB on AWS), and hardware-based load balancers. The second reason is that the Ingress object was added to Kubernetes before any of the common extensibility capabilities were added (see [Chapter 16](#)). As Ingress progresses, it is likely that it will evolve to use these mechanisms.

Installing Contour

While there are many available Ingress controllers, for the examples here we use an Ingress controller called Contour. This is a controller built to configure the open source (and CNCF project) load balancer called Envoy. Envoy is built to be dynamically configured via an API. The Contour Ingress controller takes care of translating the Ingress objects into something that Envoy can understand.



The Contour project is hosted at <https://github.com/heptio/contour>. It was created by Heptio² in collaboration with real-world customers and is used in production settings.

You can install Contour with a simple one-line invocation:

```
$ kubectl apply -f https://j.hept.io/contour-deployment-rbac
```

Note that this requires execution by a user who has `cluster-admin` permissions.

This one line works for most configurations. It creates a namespace called `heptio-contour`. Inside of that namespace it creates a deployment (with two replicas) and an external-facing service of `type: LoadBalancer`. In addition, it sets up the correct permissions via a service account and installs a CustomResourceDefinition (see [Chapter 16](#)) for some extended capabilities discussed in “[The Future of Ingress](#)” on [page 100](#).

Because it is a global install, you need to ensure that you have wide admin permissions on the cluster you are installing into.

After you install it, you can fetch the external address of Contour via:

```
$ kubectl get -n heptio-contour service contour -o wide
NAME          CLUSTER-IP      EXTERNAL-IP      PORT(S)      ...
contour       10.106.53.14    a477...amazonaws.com 80:30274/TCP ...
```

Look at the `EXTERNAL-IP` column. This can be either an IP address (for GCP and Azure) or a hostname (for AWS). Other clouds and environments may differ. If your Kubernetes cluster doesn't support services of `type: LoadBalancer`, you'll have to change the YAML for installing Contour to simply use `type: NodePort` and route traffic to machines on the cluster via a mechanism that works in your configuration.

If you are using `minikube`, you probably won't have anything listed for `EXTERNAL-IP`. To fix this, you need to open a separate terminal window and run `minikube tunnel`.

² Heptio was recently acquired by VMware, so there is a chance that this URL could change. However, GitHub will forward to the new destination.

This configures networking routes such that you have unique IP addresses assigned to every service of type: `LoadBalancer`.

Configuring DNS

To make Ingress work well, you need to configure DNS entries to the external address for your load balancer. You can map multiple hostnames to a single external endpoint and the Ingress controller will play traffic cop and direct incoming requests to the appropriate upstream service based on that hostname.

For this chapter, we assume that you have a domain called `example.com`. You need to configure two DNS entries: `alpaca.example.com` and `bandicoot.example.com`. If you have an IP address for your external load balancer, you'll want to create A records. If you have a hostname, you'll want to configure CNAME records.

Configuring a Local hosts File

If you don't have a domain or if you are using a local solution such as `minikube`, you can set up a local configuration by editing your `/etc/hosts` file to add an IP address. You need admin/root privileges on your workstation. The location of the file may differ on your platform, and making it take effect may require extra steps. For example, on Windows the file is usually at `C:\Windows\System32\drivers\etc\hosts`, and for recent versions of macOS you need to run `sudo killall -HUP mDNSResponder` after changing the file.

Edit the file to add a line like the following:

```
<ip-address> alpaca.example.com bandicoot.example.com
```

For `<ip-address>`, fill in the external IP address for Contour. If all you have is a hostname (like from AWS), you can get an IP address (that may change in the future) by executing `host -t a <address>`.

Don't forget to undo these changes when you are done!

Using Ingress

Now that we have an Ingress controller configured, let's put it through its paces. First we'll create a few upstream (also sometimes referred to as "backend") services to play with by executing the following commands:

```
$ kubectl run be-default \
  --image=gcr.io/kuar-demo/kuar-amd64:blue \
  --replicas=3 \
  --port=8080
$ kubectl expose deployment be-default
$ kubectl run alpaca \
```

```

--image=gcr.io/kuar-demo/kuard-amd64:green \
--replicas=3 \
--port=8080
$ kubectl expose deployment alpaca
$ kubectl run bandicoot \
  --image=gcr.io/kuar-demo/kuard-amd64:purple \
  --replicas=3 \
  --port=8080
$ kubectl expose deployment bandicoot
$ kubectl get services -o wide

NAME                CLUSTER-IP      ... PORT(S)    ... SELECTOR
alpaca-prod         10.115.245.13   ... 8080/TCP    ... run=alpaca
bandicoot-prod     10.115.242.3    ... 8080/TCP    ... run=bandicoot
be-default          10.115.246.6    ... 8080/TCP    ... run=be-default
kubernetes         10.115.240.1    ... 443/TCP     ... <none>

```

Simplest Usage

The simplest way to use Ingress is to have it just blindly pass everything that it sees through to an upstream service. There is limited support for imperative commands to work with Ingress in `kubectl`, so we'll start with a YAML file (see [Example 8-1](#)).

Example 8-1. simple-ingress.yaml

```

apiVersion: extensions/v1beta1
kind: Ingress
metadata:
  name: simple-ingress
spec:
  backend:
    serviceName: alpaca
    servicePort: 8080

```

Create this Ingress with `kubectl apply`:

```

$ kubectl apply -f simple-ingress.yaml
ingress.extensions/simple-ingress created

```

You can verify that it was set up correctly using `kubectl get` and `kubectl describe`:

```

$ kubectl get ingress
NAME                HOSTS    ADDRESS    PORTS    AGE
simple-ingress      *                80        13m

$ kubectl describe ingress simple-ingress
Name:                simple-ingress
Namespace:           default
Address:
Default backend:     be-default:8080
(172.17.0.6:8080,172.17.0.7:8080,172.17.0.8:8080)

```

```

Rules:
  Host Path Backends
  ---- -
  *    *    be-default:8080 (172.17.0.6:8080,172.17.0.7:8080,172.17.0.8:8080)
Annotations:
  ...

Events: <none>

```

This sets things up so that *any* HTTP request that hits the Ingress controller is forwarded on to the alpaca service. You can now access the alpaca instance of kuard on any of the raw IPs/CNAMEs of the service; in this case, either alpaca.example.com or bandicoot.example.com.

This doesn't, at this point, add much value above a simple service of type: LoadBalancer. We experiment with more complex configurations in the following sections.

Using Hostnames

Things start to get interesting when we start to direct traffic based on properties of the request. The most common example of this is to have the Ingress system look at the HTTP host header (which is set to the DNS domain in the original URL) and direct traffic based on that header. Let's add *another* Ingress object for directing traffic to the alpaca service for any traffic directed to alpaca.example.com (see [Example 8-2](#)).

Example 8-2. host-ingress.yaml

```

apiVersion: extensions/v1beta1
kind: Ingress
metadata:
  name: host-ingress
spec:
  rules:
  - host: alpaca.example.com
    http:
      paths:
      - backend:
          serviceName: alpaca
          servicePort: 8080

```

Create this Ingress with `kubectl apply`:

```
$ kubectl apply -f host-ingress.yaml
ingress.extensions/host-ingress created
```

We can verify that things are set up correctly as follows:

```
$ kubectl get ingress
NAME                HOSTS                ADDRESS    PORTS    AGE
host-ingress        alpaca.example.com  80         80       54s
simple-ingress       *                   80         80       13m

$ kubectl describe ingress host-ingress
Name:                host-ingress
Namespace:           default
Address:
Default backend:     default-http-backend:80 (<none>)
Rules:
  Host                Path  Backends
  ----                -
  alpaca.example.com  /    alpaca:8080 (<none>)
Annotations:
  ...

Events: <none>
```

There are a couple of things that are a bit confusing here. First, there is a reference to the `default-http-backend`. This is a convention that only some Ingress controllers use to handle requests that aren't handled in any other way. These controllers send those requests to a service called `default-http-backend` in the `kube-system` namespace. This convention is surfaced client-side in `kubectl`.

Next, there are no endpoints listed for the `alpaca` backend service. This is a bug in `kubectl` that is fixed in Kubernetes v1.14.

Regardless, you should now be able to address the `alpaca` service via `http://alpaca.example.com`. If instead you reach the service endpoint via other methods, you should get the default service.

Using Paths

The next interesting scenario is to direct traffic based on not just the hostname, but also the path in the HTTP request. We can do this easily by specifying a path in the `paths` entry (see [Example 8-3](#)). In this example we direct everything coming into `http://bandicoot.example.com` to the `bandicoot` service, but we also send `http://bandicoot.example.com/a` to the `alpaca` service. This type of scenario can be used to host multiple services on different paths of a single domain.

Example 8-3. *path-ingress.yaml*

```
apiVersion: extensions/v1beta1
kind: Ingress
metadata:
  name: path-ingress
spec:
  rules:
  - host: bandicoot.example.com
    http:
      paths:
      - path: "/"
        backend:
          serviceName: bandicoot
          servicePort: 8080
      - path: "/a/"
        backend:
          serviceName: alpaca
          servicePort: 8080
```

When there are multiple paths on the same host listed in the Ingress system, the longest prefix matches. So, in this example, traffic starting with `/a/` is forwarded to the `alpaca` service, while all other traffic (starting with `/`) is directed to the `bandicoot` service.

As requests get proxied to the upstream service, the path remains unmodified. That means a request to `bandicoot.example.com/a/` shows up to the upstream server that is configured for that request hostname and path. The upstream service needs to be ready to serve traffic on that subpath. In this case, `kuard` has special code for testing, where it responds on the root path (`/`) along with a predefined set of subpaths (`/a/`, `/b/`, and `/c/`).

Cleaning Up

To clean up, execute the following:

```
$ kubectl delete ingress host-ingress path-ingress simple-ingress
$ kubectl delete service alpaca bandicoot be-default
$ kubectl delete deployment alpaca bandicoot be-default
```

Advanced Ingress Topics and Gotchas

There are some other fancy features that are supported by Ingress. The level of support for these features differs based on the Ingress controller implementation, and two controllers may implement a feature in slightly different ways.

Many of the extended features are exposed via annotations on the Ingress object. Be careful, as these annotations can be hard to validate and are easy to get wrong. Many

of these annotations apply to the entire Ingress object and so can be more general than you might like. To scope the annotations down you can always split a single Ingress object into multiple Ingress objects. The Ingress controller should read them and merge them together.

Running Multiple Ingress Controllers

Oftentimes, you may want to run multiple Ingress controllers on a single cluster. In that case, you specify which Ingress object is meant for which Ingress controller using the `kubernetes.io/ingress.class` annotation. The value should be a string that specifies which Ingress controller should look at this object. The Ingress controllers themselves, then, should be configured with that same string and should only respect those Ingress objects with the correct annotation.

If the `kubernetes.io/ingress.class` annotation is missing, behavior is undefined. It is likely that multiple controllers will fight to satisfy the Ingress and write the status field of the Ingress objects.

Multiple Ingress Objects

If you specify multiple Ingress objects, the Ingress controllers should read them all and try to merge them into a coherent configuration. However, if you specify duplicate and conflicting configurations, the behavior is undefined. It is likely that different Ingress controllers will behave differently. Even a single implementation may do different things depending on nonobvious factors.

Ingress and Namespaces

Ingress interacts with namespaces in some nonobvious ways.

First, due to an abundance of security caution, an Ingress object can only refer to an upstream service in the same namespace. This means that you can't use an Ingress object to point a subpath to a service in another namespace.

However, multiple Ingress objects in different namespaces can specify subpaths for the same host. These Ingress objects are then merged together to come up with the final config for the Ingress controller.

This cross-namespace behavior means that it is necessary that Ingress be coordinated globally across the cluster. If not coordinated carefully, an Ingress object in one namespace could cause problems (and undefined behavior) in other namespaces.

Typically there are no restrictions built into the Ingress controller around what namespaces are allowed to specify what hostnames and paths. Advanced users may try to enforce a policy for this using a custom admission controller. There are also

evolutions of Ingress described in “The Future of Ingress” on page 100 that address this problem.

Path Rewriting

Some Ingress controller implementations support, optionally, doing path rewriting. This can be used to modify the path in the HTTP request as it gets proxied. This is usually specified by an annotation on the Ingress object and applies to all requests that are specified by that object. For example, if we were using the NGINX Ingress controller, we could specify an annotation of `nginx.ingress.kubernetes.io/rewrite-target: /`. This can sometimes make upstream services work on a subpath even if they weren’t built to do so.

There are multiple implementations that not only implement path rewriting, but also support regular expressions when specifying the path. For example, the NGINX controller allows regular expressions to capture parts of the path and then use that captured content when doing rewriting. How this is done (and what variant of regular expressions is used) is implementation-specific.

Path rewriting isn’t a silver bullet, though, and can often lead to bugs. Many web applications assume that they can link within themselves using absolute paths. In that case, the app in question may be hosted on `/subpath` but have requests show up to it on `/`. It may then send a user to `/app-path`. There is then the question of whether that is an “internal” link for the app (in which case it should instead be `/subpath/app-path`) or a link to some other app. For this reason, it is probably best to avoid subpaths if you can help it for any complicated applications.

Serving TLS

When serving websites, it is becoming increasingly necessary to do so securely using TLS and HTTPS. Ingress supports this (as do most Ingress controllers).

First, users need to specify a secret with their TLS certificate and keys—something like what is outlined in [Example 8-4](#). You can also create a secret imperatively with `kubectl create secret tls <secret-name> --cert <certificate-pem-file> --key <private-key-pem-file>`.

Example 8-4. tls-secret.yaml

```
apiVersion: v1
kind: Secret
metadata:
  creationTimestamp: null
  name: tls-secret-name
type: kubernetes.io/tls
data:
```

```
tls.crt: <base64 encoded certificate>
tls.key: <base64 encoded private key>
```

Once you have the certificate uploaded, you can reference it in an Ingress object. This specifies a list of certificates along with the hostnames that those certificates should be used for (see [Example 8-5](#)). Again, if multiple Ingress objects specify certificates for the same hostname, the behavior is undefined.

Example 8-5. `tls-ingress.yaml`

```
apiVersion: extensions/v1beta1
kind: Ingress
metadata:
  name: tls-ingress
spec:
  tls:
  - hosts:
    - alpaca.example.com
    secretName: tls-secret-name
  rules:
  - host: alpaca.example.com
    http:
      paths:
      - backend:
          serviceName: alpaca
          servicePort: 8080
```

Uploading and managing TLS secrets can be difficult. In addition, certificates can often come at a significant cost. To help solve this problem, there is a **non-profit** called “**Let’s Encrypt**” running a free Certificate Authority that is API-driven. Since it is API-driven, it is possible to set up a Kubernetes cluster that automatically fetches and installs TLS certificates for you. It can be tricky to set up, but when working it’s very simple to use. The missing piece is an open source project called **cert-manager** initiated and supported by Jetstack, a UK startup. Visit its [GitHub page](#) for instructions on installing and using `cert-manager`.

Alternate Ingress Implementations

There are many different implementations of Ingress controllers, each building on the base Ingress object with unique features. It is a vibrant ecosystem.

First, each cloud provider has an Ingress implementation that exposes the specific cloud-based L7 load balancer for that cloud. Instead of configuring a software load balancer running in a Pod, these controllers take Ingress objects and use them to configure, via an API, the cloud-based load balancers. This reduces the load on the cluster and management burden for the operators, but can often come at a cost.

The most popular generic Ingress controller is probably the open source **NGINX ingress controller**. Be aware that there is also a commercial controller based on the proprietary NGINX Plus. The open source controller essentially reads Ingress objects and merges them into an NGINX configuration file. It then signals to the NGINX process to restart with the new configuration (while responsibly serving existing in-flight connections). The open NGINX controller has an enormous number of features and options exposed via **annotations**.

Ambassador and **Gloo** are two other Envoy-based Ingress controllers that are focused on being API gateways.

Traefik is a reverse proxy implemented in Go that also can function as an Ingress controller. It has a set of features and dashboards that are very developer-friendly.

This just scratches the surface. The Ingress ecosystem is very active and there are many new projects and commercial offerings that build on the humble Ingress object in unique ways.

The Future of Ingress

As you have seen, the Ingress object provides a very useful abstraction for configuring L7 load balancers—but it hasn't scaled to all the features that users want and various implementations are looking to offer.

Many of the features in Ingress are underdefined. Implementations can surface these features in different ways, reducing the portability of configurations between implementations.

Another problem is that it is easy to misconfigure Ingress. The way that multiple objects compose together opens the door for conflicts that are resolved differently by different implementations. In addition, the way that these are merged across namespaces breaks the idea of namespace isolation.

Ingress was also created before the idea of a Service Mesh (exemplified by projects such as Istio and Linkerd) was well known. The intersection of Ingress and Service Meshes is still being defined.

There are a lot of great ideas floating around the community. For example, Istio implements the idea of a gateway that overlaps with Ingress in some ways. Contour introduces a new type called IngressRoute that is a better-defined and more explicit version of Ingress inspired by other network protocols like DNS. Defining the next step for Ingress is a hard problem. It involves creating a common language that applies to most load balancers, while at the same time leaving room for innovation of new features and allowing different implementations to specialize in other directions. This is an active area of innovation in the Kubernetes community through **the Network Special Interest Group**.

Summary

Ingress is a unique system in Kubernetes. It is simply a schema, and the implementations of a controller for that schema must be installed and managed separately. But it is also a critical system for exposing services to users in a practical and cost-efficient way. As Kubernetes continues to mature, expect to see Ingress become more and more relevant.

ReplicaSets

Previously, we covered how to run individual containers as Pods. But these Pods are essentially one-off singletons. More often than not, you want multiple replicas of a container running at a particular time. There are a variety of reasons for this type of replication:

Redundancy

Multiple running instances mean failure can be tolerated.

Scale

Multiple running instances mean that more requests can be handled.

Sharding

Different replicas can handle different parts of a computation in parallel.

Of course, you could manually create multiple copies of a Pod using multiple different (though largely similar) Pod manifests, but doing so is both tedious and error-prone. Logically, a user managing a replicated set of Pods considers them as a single entity to be defined and managed. This is precisely what a ReplicaSet is. A ReplicaSet acts as a cluster-wide Pod manager, ensuring that the right types and number of Pods are running at all times.

Because ReplicaSets make it easy to create and manage replicated sets of Pods, they are the building blocks used to describe common application deployment patterns and provide the underpinnings of self-healing for our applications at the infrastructure level. Pods managed by ReplicaSets are automatically rescheduled under certain failure conditions, such as node failures and network partitions.

The easiest way to think of a ReplicaSet is that it combines a cookie cutter and a desired number of cookies into a single API object. When we define a ReplicaSet, we define a specification for the Pods we want to create (the “cookie cutter”), and a

desired number of replicas. Additionally, we need to define a way of finding Pods that the ReplicaSet should control. The actual act of managing the replicated Pods is an example of a *reconciliation loop*. Such loops are fundamental to most of the design and implementation of Kubernetes.



The decision to embed the definition of a Pod inside a ReplicaSet (and a deployment, and a job, and...) is one of the more interesting ones in Kubernetes. In retrospect, it probably would have been a better decision to use a reference to the PodTemplate object rather than embedding it directly.

Reconciliation Loops

The central concept behind a reconciliation loop is the notion of *desired* state versus *observed* or *current* state. Desired state is the state you want. With a ReplicaSet, it is the desired number of replicas and the definition of the Pod to replicate. For example, “the desired state is that there are three replicas of a Pod running the kuard server.”

In contrast, the current state is the currently observed state of the system. For example, “there are only two kuard Pods currently running.”

The reconciliation loop is constantly running, observing the current state of the world and taking action to try to make the observed state match the desired state. For instance, with the previous examples, the reconciliation loop would create a new kuard Pod in an effort to make the observed state match the desired state of three replicas.

There are many benefits to the reconciliation loop approach to managing state. It is an inherently goal-driven, self-healing system, yet it can often be easily expressed in a few lines of code.

As a concrete example of this, note that the reconciliation loop for ReplicaSets is a single loop, yet it handles user actions to scale up or scale down the ReplicaSet as well as node failures or nodes rejoining the cluster after being absent.

We’ll see numerous examples of reconciliation loops in action throughout the rest of the book.

Relating Pods and ReplicaSets

One of the key themes that runs through Kubernetes is decoupling. In particular, it’s important that all of the core concepts of Kubernetes are modular with respect to each other and that they are swappable and replaceable with other components. In this spirit, the relationship between ReplicaSets and Pods is loosely coupled. Though ReplicaSets create and manage Pods, they do not own the Pods they create. Replica-

Sets use label queries to identify the set of Pods they should be managing. They then use the exact same Pod API that you used directly in [Chapter 5](#) to create the Pods that they are managing. This notion of “coming in the front door” is another central design concept in Kubernetes. In a similar decoupling, ReplicaSets that create multiple Pods and the services that load-balance to those Pods are also totally separate, decoupled API objects. In addition to supporting modularity, the decoupling of Pods and ReplicaSets enables several important behaviors, discussed in the following sections.

Adopting Existing Containers

Despite the value placed on declarative configuration of software, there are times when it is easier to build something up imperatively. In particular, early on you may be simply deploying a single Pod with a container image without a ReplicaSet managing it. But at some point you may want to expand your singleton container into a replicated service and create and manage an array of similar containers. You may have even defined a load balancer that is serving traffic to that single Pod. If ReplicaSets owned the Pods they created, then the only way to start replicating your Pod would be to delete it and then relaunch it via a ReplicaSet. This might be disruptive, as there would be a moment in time when there would be no copies of your container running. However, because ReplicaSets are decoupled from the Pods they manage, you can simply create a ReplicaSet that will “adopt” the existing Pod, and scale out additional copies of those containers. In this way, you can seamlessly move from a single imperative Pod to a replicated set of Pods managed by a ReplicaSet.

Quarantining Containers

Oftentimes, when a server misbehaves, Pod-level health checks will automatically restart that Pod. But if your health checks are incomplete, a Pod can be misbehaving but still be part of the replicated set. In these situations, while it would work to simply kill the Pod, that would leave your developers with only logs to debug the problem. Instead, you can modify the set of labels on the sick Pod. Doing so will disassociate it from the ReplicaSet (and service) so that you can debug the Pod. The ReplicaSet controller will notice that a Pod is missing and create a new copy, but because the Pod is still running it is available to developers for interactive debugging, which is significantly more valuable than debugging from logs.

Designing with ReplicaSets

ReplicaSets are designed to represent a single, scalable microservice inside your architecture. The key characteristic of ReplicaSets is that every Pod that is created by the ReplicaSet controller is entirely homogeneous. Typically, these Pods are then fronted by a Kubernetes service load balancer, which spreads traffic across the Pods

that make up the service. Generally speaking, ReplicaSets are designed for stateless (or nearly stateless) services. The elements created by the ReplicaSet are interchangeable; when a ReplicaSet is scaled down, an arbitrary Pod is selected for deletion. Your application's behavior shouldn't change because of such a scale-down operation.

ReplicaSet Spec

Like all objects in Kubernetes, ReplicaSets are defined using a specification. All ReplicaSets must have a unique name (defined using the `metadata.name` field), a `spec` section that describes the number of Pods (replicas) that should be running cluster-wide at any given time, and a Pod template that describes the Pod to be created when the defined number of replicas is not met. [Example 9-1](#) shows a minimal ReplicaSet definition.

Example 9-1. kuard-rs.yaml

```
apiVersion: extensions/v1beta1
kind: ReplicaSet
metadata:
  name: kuard
spec:
  replicas: 1
  template:
    metadata:
      labels:
        app: kuard
        version: "2"
    spec:
      containers:
        - name: kuard
          image: "gcr.io/kuar-demo/kuard-amd64:green"
```

Pod Templates

As mentioned previously, when the number of Pods in the current state is less than the number of Pods in the desired state, the ReplicaSet controller will create new Pods. The Pods are created using a Pod template that is contained in the ReplicaSet specification. The Pods are created in exactly the same manner as when you created a Pod from a YAML file in previous chapters, but instead of using a file, the Kubernetes ReplicaSet controller creates and submits a Pod manifest based on the Pod template directly to the API server.

The following shows an example of a Pod template in a ReplicaSet:

```
template:
  metadata:
    labels:
```

```
    app: helloworld
    version: v1
spec:
  containers:
  - name: helloworld
    image: kelseyhightower/helloworld:v1
    ports:
    - containerPort: 80
```

Labels

In any cluster of reasonable size, there are many different Pods running at any given time—so how does the ReplicaSet reconciliation loop discover the set of Pods for a particular ReplicaSet? ReplicaSets monitor cluster state using a set of Pod labels. Labels are used to filter Pod listings and track Pods running within a cluster. When initially created, a ReplicaSet fetches a Pod listing from the Kubernetes API and filters the results by labels. Based on the number of Pods returned by the query, the ReplicaSet deletes or creates Pods to meet the desired number of replicas. The labels used for filtering are defined in the ReplicaSet spec section and are the key to understanding how ReplicaSets work.



The selector in the ReplicaSet spec should be a proper subset of the labels in the Pod template.

Creating a ReplicaSet

ReplicaSets are created by submitting a ReplicaSet object to the Kubernetes API. In this section we will create a ReplicaSet using a configuration file and the `kubectl apply` command.

The ReplicaSet configuration file in [Example 9-1](#) will ensure one copy of the `gcr.io/kuar-demo/kuard-amd64:green` container is running at any given time.

Use the `kubectl apply` command to submit the `kuard` ReplicaSet to the Kubernetes API:

```
$ kubectl apply -f kuard-rs.yaml
replicaset "kuard" created
```

Once the `kuard` ReplicaSet has been accepted, the ReplicaSet controller will detect that there are no `kuard` Pods running that match the desired state, and a new `kuard` Pod will be created based on the contents of the Pod template:

```
$ kubectl get pods
NAME          READY   STATUS    RESTARTS   AGE
kuard-yvzgd   1/1     Running   0           11s
```

Inspecting a ReplicaSet

As with Pods and other Kubernetes API objects, if you are interested in further details about a ReplicaSet, the `describe` command will provide much more information about its state. Here is an example of using `describe` to obtain the details of the ReplicaSet we previously created:

```
$ kubectl describe rs kuard
Name:          kuard
Namespace:    default
Image(s):     kuard:1.9.15
Selector:     app=kuard,version=2
Labels:       app=kuard,version=2
Replicas:     1 current / 1 desired
Pods Status:  1 Running / 0 Waiting / 0 Succeeded / 0 Failed
No volumes.
```

You can see the label selector for the ReplicaSet, as well as the state of all of the replicas managed by the ReplicaSet.

Finding a ReplicaSet from a Pod

Sometimes you may wonder if a Pod is being managed by a ReplicaSet, and if it is, which ReplicaSet.

To enable this kind of discovery, the ReplicaSet controller adds an annotation to every Pod that it creates. The key for the annotation is `kubernetes.io/created-by`. If you run the following, look for the `kubernetes.io/created-by` entry in the annotations section:

```
$ kubectl get pods <pod-name> -o yaml
```

If applicable, this will list the name of the ReplicaSet that is managing this Pod. Note that such annotations are best-effort; they are only created when the Pod is created by the ReplicaSet, and can be removed by a Kubernetes user at any time.

Finding a Set of Pods for a ReplicaSet

You can also determine the set of Pods managed by a ReplicaSet. First, you can get the set of labels using the `describe` command. In the previous example, the label selector was `app=kuard,version=2`. To find the Pods that match this selector, use the `--selector` flag or the shorthand `-l`:

```
$ kubectl get pods -l app=kuard,version=2
```

This is exactly the same query that the ReplicaSet executes to determine the current number of Pods.

Scaling ReplicaSets

ReplicaSets are scaled up or down by updating the `spec.replicas` key on the ReplicaSet object stored in Kubernetes. When a ReplicaSet is scaled up, new Pods are submitted to the Kubernetes API using the Pod template defined on the ReplicaSet.

Imperative Scaling with `kubectl scale`

The easiest way to achieve this is using the `scale` command in `kubectl`. For example, to scale up to four replicas you could run:

```
$ kubectl scale replicaset kuard --replicas=4
```

While such imperative commands are useful for demonstrations and quick reactions to emergency situations (e.g., in response to a sudden increase in load), it is important to also update any text-file configurations to match the number of replicas that you set via the imperative `scale` command. The reason for this becomes obvious when you consider the following scenario:

Alice is on call, when suddenly there is a large increase in load on the service she is managing. Alice uses the `scale` command to increase the number of servers responding to requests to 10, and the situation is resolved. However, Alice forgets to update the ReplicaSet configurations checked into source control. Several days later, Bob is preparing the weekly rollouts. Bob edits the ReplicaSet configurations stored in version control to use the new container image, but he doesn't notice that the number of replicas in the file is currently 5, not the 10 that Alice set in response to the increased load. Bob proceeds with the rollout, which both updates the container image and reduces the number of replicas by half, causing an immediate overload or outage.

Hopefully, this illustrates the need to ensure that any imperative changes are immediately followed by a declarative change in source control. Indeed, if the need is not acute, we generally recommend only making declarative changes as described in the following section.

Declaratively Scaling with `kubectl apply`

In a declarative world, we make changes by editing the configuration file in version control and then applying those changes to our cluster. To scale the `kuard` ReplicaSet, edit the `kuard-rs.yaml` configuration file and set the `replicas` count to 3:

```
...
spec:
  replicas: 3
...
```

In a multiuser setting, you would like to have a documented code review of this change and eventually check the changes into version control. Either way, you can then use the `kubectl apply` command to submit the updated `kuard` ReplicaSet to the API server:

```
$ kubectl apply -f kuard-rs.yaml
replicaset "kuard" configured
```

Now that the updated `kuard` ReplicaSet is in place, the ReplicaSet controller will detect that the number of desired Pods has changed and that it needs to take action to realize that desired state. If you used the imperative `scale` command in the previous section, the ReplicaSet controller will destroy one Pod to get the number to three. Otherwise, it will submit two new Pods to the Kubernetes API using the Pod template defined on the `kuard` ReplicaSet. Regardless, use the `kubectl get pods` command to list the running `kuard` Pods. You should see output like the following:

```
$ kubectl get pods
NAME          READY   STATUS    RESTARTS   AGE
kuard-3a2sb   1/1     Running   0           26s
kuard-wuq9v   1/1     Running   0           26s
kuard-yvzgd   1/1     Running   0           2m
```

Autoscaling a ReplicaSet

While there will be times when you want to have explicit control over the number of replicas in a ReplicaSet, often you simply want to have “enough” replicas. The definition varies depending on the needs of the containers in the ReplicaSet. For example, with a web server like NGINX, you may want to scale due to CPU usage. For an in-memory cache, you may want to scale with memory consumption. In some cases you may want to scale in response to custom application metrics. Kubernetes can handle all of these scenarios via *Horizontal Pod Autoscaling* (HPA).



HPA requires the presence of the `heapster` Pod on your cluster. `heapster` keeps track of metrics and provides an API for consuming metrics that HPA uses when making scaling decisions. Most installations of Kubernetes include `heapster` by default. You can validate its presence by listing the Pods in the `kube-system` namespace:

```
$ kubectl get pods --namespace=kube-system
```

You should see a Pod named `heapster` somewhere in that list. If you do not see it, autoscaling will not work correctly.

“Horizontal Pod Autoscaling” is kind of a mouthful, and you might wonder why it is not simply called “autoscaling.” Kubernetes makes a distinction between *horizontal* scaling, which involves creating additional replicas of a Pod, and *vertical* scaling,

which involves increasing the resources required for a particular Pod (e.g., increasing the CPU required for the Pod). Vertical scaling is not currently implemented in Kubernetes, but it is planned. Additionally, many solutions also enable *cluster* autoscaling, where the number of machines in the cluster is scaled in response to resource needs, but this solution is not covered here.

Autoscaling based on CPU

Scaling based on CPU usage is the most common use case for Pod autoscaling. Generally it is most useful for request-based systems that consume CPU proportionally to the number of requests they are receiving, while using a relatively static amount of memory.

To scale a ReplicaSet, you can run a command like the following:

```
$ kubectl autoscale rs kuard --min=2 --max=5 --cpu-percent=80
```

This command creates an autoscaler that scales between two and five replicas with a CPU threshold of 80%. To view, modify, or delete this resource you can use the standard `kubectl` commands and the `horizontalpodautoscalers` resource. `horizontalpodautoscalers` is quite a bit to type, but it can be shortened to `hpa`:

```
$ kubectl get hpa
```



Because of the decoupled nature of Kubernetes, there is no direct link between the HPA and the ReplicaSet. While this is great for modularity and composition, it also enables some anti-patterns. In particular, it's a bad idea to combine both autoscaling and imperative or declarative management of the number of replicas. If both you and an autoscaler are attempting to modify the number of replicas, it's highly likely that you will clash, resulting in unexpected behavior.

Deleting ReplicaSets

When a ReplicaSet is no longer required it can be deleted using the `kubectl delete` command. By default, this also deletes the Pods that are managed by the ReplicaSet:

```
$ kubectl delete rs kuard
replicaset "kuard" deleted
```

Running the `kubectl get pods` command shows that all the `kuard` Pods created by the `kuard` ReplicaSet have also been deleted:

```
$ kubectl get pods
```

If you don't want to delete the Pods that are being managed by the ReplicaSet, you can set the `--cascade` flag to `false` to ensure only the ReplicaSet object is deleted and not the Pods:

```
$ kubectl delete rs kuard --cascade=false
```

Summary

Composing Pods with ReplicaSets provides the foundation for building robust applications with automatic failover, and makes deploying those applications a breeze by enabling scalable and sane deployment patterns. ReplicaSets should be used for any Pod you care about, even if it is a single Pod! Some people even default to using ReplicaSets instead of Pods. A typical cluster will have many ReplicaSets, so apply liberally to the affected area.

Deployments

So far, you have seen how to package your applications as containers, create replicated sets of containers, and use Ingress controllers to load-balance traffic to your services. All of these objects (Pods, ReplicaSets, and Services) are used to build a single instance of your application. However, they do little to help you manage the daily or weekly cadence of releasing new versions of your application. Indeed, both Pods and ReplicaSets are expected to be tied to specific container images that don't change.

The Deployment object exists to manage the release of new versions. Deployments represent deployed applications in a way that transcends any particular version. Additionally, deployments enable you to easily move from one version of your code to the next. This “rollout” process is specifiable and careful. It waits for a user-configurable amount of time between upgrading individual Pods. It also uses health checks to ensure that the new version of the application is operating correctly, and stops the deployment if too many failures occur.

Using deployments you can simply and reliably roll out new software versions without downtime or errors. The actual mechanics of the software rollout performed by a deployment is controlled by a deployment controller that runs in the Kubernetes cluster itself. This means you can let a deployment proceed unattended and it will still operate correctly and safely. This makes it easy to integrate deployments with numerous continuous delivery tools and services. Further, running server-side makes it safe to perform a rollout from places with poor or intermittent internet connectivity. Imagine rolling out a new version of your software from your phone while riding on the subway. Deployments make this possible and safe!



When Kubernetes was first released, one of the most popular demonstrations of its power was the “rolling update,” which showed how you could use a single command to seamlessly update a running application without any downtime and without losing requests. This original demo was based on the `kubectl rolling-update` command, which is still available in the command-line tool, although its functionality has largely been subsumed by the Deployment object.

Your First Deployment

Like all objects in Kubernetes, a deployment can be represented as a declarative YAML object that provides the details about what you want to run. In the following case, the deployment is requesting a single instance of the `kuard` application:

```
apiVersion: extensions/v1beta1
kind: Deployment
metadata:
  name: kuard
spec:
  selector:
    matchLabels:
      run: kuard
  replicas: 1
  template:
    metadata:
      labels:
        run: kuard
    spec:
      containers:
      - name: kuard
        image: gcr.io/kuar-demo/kuard-amd64:blue
```

Save this YAML file as `kuard-deployment.yaml`, then you can create it using:

```
$ kubectl create -f kuard-deployment.yaml
```

Deployment Internals

Let’s explore how deployments actually work. Just as we learned that ReplicaSets manage Pods, deployments manage ReplicaSets. As with all relationships in Kubernetes, this relationship is defined by labels and a label selector. You can see the label selector by looking at the Deployment object:

```
$ kubectl get deployments kuard \
  -o jsonpath --template {.spec.selector.matchLabels}

map[run:kuard]
```

From this you can see that the deployment is managing a ReplicaSet with the label `run=kuard`. We can use this in a label selector query across ReplicaSets to find that specific ReplicaSet:

```
$ kubectl get replicaset --selector=run=kuard
```

NAME	DESIRED	CURRENT	READY	AGE
kuard-1128242161	1	1	1	13m

Now let's see the relationship between a deployment and a ReplicaSet in action. We can resize the deployment using the imperative scale command:

```
$ kubectl scale deployments kuard --replicas=2
```

```
deployment.extensions/kuard scaled
```

Now if we list that ReplicaSet again, we should see:

```
$ kubectl get replicaset --selector=run=kuard
```

NAME	DESIRED	CURRENT	READY	AGE
kuard-1128242161	2	2	2	13m

Scaling the deployment has also scaled the ReplicaSet it controls.

Now let's try the opposite, scaling the ReplicaSet:

```
$ kubectl scale replicaset kuard-1128242161 --replicas=1
```

```
replicaset "kuard-1128242161" scaled
```

Now get that ReplicaSet again:

```
$ kubectl get replicaset --selector=run=kuard
```

NAME	DESIRED	CURRENT	READY	AGE
kuard-1128242161	2	2	2	13m

That's odd. Despite our scaling the ReplicaSet to one replica, it still has two replicas as its desired state. What's going on? Remember, Kubernetes is an online, self-healing system. The top-level Deployment object is managing this ReplicaSet. When you adjust the number of replicas to one, it no longer matches the desired state of the deployment, which has `replicas` set to 2. The deployment controller notices this and takes action to ensure the observed state matches the desired state, in this case readjusting the number of replicas back to two.

If you ever want to manage that ReplicaSet directly, you need to delete the deployment (remember to set `--cascade` to `false`, or else it will delete the ReplicaSet and Pods as well!).

Creating Deployments

Of course, as has been stated elsewhere, you should have a preference for declarative management of your Kubernetes configurations. This means maintaining the state of your deployments in YAML or JSON files on disk.

As a starting point, download this deployment into a YAML file:

```
$ kubectl get deployments kuard --export -o yaml > kuard-deployment.yaml
$ kubectl replace -f kuard-deployment.yaml --save-config
```

If you look in the file, you will see something like this:

```
apiVersion: extensions/v1beta1
kind: Deployment
metadata:
  annotations:
    deployment.kubernetes.io/revision: "1"
  creationTimestamp: null
  generation: 1
  labels:
    run: kuard
  name: kuard
  selfLink: /apis/extensions/v1beta1/namespaces/default/deployments/kuard
spec:
  progressDeadlineSeconds: 2147483647
  replicas: 2
  revisionHistoryLimit: 10
  selector:
    matchLabels:
      run: kuard
  strategy:
    rollingUpdate:
      maxSurge: 1
      maxUnavailable: 1
    type: RollingUpdate
  template:
    metadata:
      creationTimestamp: null
      labels:
        run: kuard
    spec:
      containers:
      - image: gcr.io/kuar-demo/kuard-amd64:blue
        imagePullPolicy: IfNotPresent
        name: kuard
        resources: {}
        terminationMessagePath: /dev/termination-log
        terminationMessagePolicy: File
      dnsPolicy: ClusterFirst
      restartPolicy: Always
      schedulerName: default-scheduler
```

```
securityContext: {}
terminationGracePeriodSeconds: 30
status: {}
```



A lot of read-only and default fields were removed in the preceding listing for brevity. You also need to run `kubectl replace --save-config`. This adds an annotation so that, when applying changes in the future, `kubectl` will know what the last applied configuration was for smarter merging of configs. If you always use `kubectl apply`, this step is only required after the first time you create a deployment using `kubectl create -f`.

The deployment spec has a very similar structure to the `ReplicaSet` spec. There is a Pod template, which contains a number of containers that are created for each replica managed by the deployment. In addition to the Pod specification, there is also a strategy object:

```
...
strategy:
  rollingUpdate:
    maxSurge: 1
    maxUnavailable: 1
  type: RollingUpdate
...
```

The strategy object dictates the different ways in which a rollout of new software can proceed. There are two different strategies supported by deployments: `Recreate` and `RollingUpdate`.

These are discussed in detail later in this chapter.

Managing Deployments

As with all Kubernetes objects, you can get detailed information about your deployment via the `kubectl describe` command:

```
$ kubectl describe deployments kuard

Name:                kuard
Namespace:           default
CreationTimestamp:   Tue, 16 Apr 2019 21:43:25 -0700
Labels:              run=kuard
Annotations:         deployment.kubernetes.io/revision: 1
Selector:            run=kuard
Replicas:            2 desired | 2 updated | 2 total | 2 available | 0 ...
StrategyType:        RollingUpdate
MinReadySeconds:     0
RollingUpdateStrategy: 1 max unavailable, 1 max surge
```

```

Pod Template:
  Labels:  run=kuard
  Containers:
    kuard:
      Image:   gcr.io/kuar-demo/kuard-amd64:blue
      Port:    <none>
      Host Port: <none>
      Environment: <none>
      Mounts:  <none>
  Volumes:  <none>
Conditions:
  Type          Status  Reason
  ----          -
  Available     True    MinimumReplicasAvailable
OldReplicaSets: <none>
NewReplicaSet:  kuard-6d69d9fc5c (2/2 replicas created)
Events:
  Type    Reason             Age          From              Message
  ----    -
  Normal  ScalingReplicaSet  4m6s        deployment-con...  ...
  Normal  ScalingReplicaSet  113s (x2 over 3m20s) deployment-con...  ...

```

In the output of `describe` there is a great deal of important information.

Two of the most important pieces of information in the output are `OldReplicaSets` and `NewReplicaSet`. These fields point to the `ReplicaSet` objects this deployment is currently managing. If a deployment is in the middle of a rollout, both fields will be set to a value. If a rollout is complete, `OldReplicaSets` will be set to `<none>`.

In addition to the `describe` command, there is also the `kubectl rollout` command for deployments. We will go into this command in more detail later on, but for now, know that you can use `kubectl rollout history` to obtain the history of rollouts associated with a particular deployment. If you have a current deployment in progress, you can use `kubectl rollout status` to obtain the current status of a rollout.

Updating Deployments

Deployments are declarative objects that describe a deployed application. The two most common operations on a deployment are scaling and application updates.

Scaling a Deployment

Although we previously showed how you could imperatively scale a deployment using the `kubectl scale` command, the best practice is to manage your deployments declaratively via the YAML files, and then use those files to update your deployment. To scale up a deployment, you would edit your YAML file to increase the number of replicas:

```
...
spec:
  replicas: 3
...
```

Once you have saved and committed this change, you can update the deployment using the `kubectl apply` command:

```
$ kubectl apply -f kuard-deployment.yaml
```

This will update the desired state of the deployment, causing it to increase the size of the ReplicaSet it manages, and eventually create a new Pod managed by the deployment:

```
$ kubectl get deployments kuard
```

NAME	DESIRED	CURRENT	UP-TO-DATE	AVAILABLE	AGE
kuard	3	3	3	3	4m

Updating a Container Image

The other common use case for updating a deployment is to roll out a new version of the software running in one or more containers. To do this, you should likewise edit the deployment YAML file, though in this case you are updating the container image, rather than the number of replicas:

```
...
  containers:
  - image: gcr.io/kuar-demo/kuard-amd64:green
    imagePullPolicy: Always
...
```

We are also going to put an annotation in the template for the deployment to record some information about the update:

```
...
spec:
  ...
  template:
    metadata:
      annotations:
        kubernetes.io/change-cause: "Update to green kuard"
...
```



Make sure you add this annotation to the template and not the deployment itself, since the `kubectl apply` command uses this field in the Deployment object. Also, do not update the `change-cause` annotation when doing simple scaling operations. A modification of `change-cause` is a significant change to the template and will trigger a new rollout.

Again, you can use `kubectl apply` to update the deployment:

```
$ kubectl apply -f kuard-deployment.yaml
```

After you update the deployment it will trigger a rollout, which you can then monitor via the `kubectl rollout` command:

```
$ kubectl rollout status deployments kuard
deployment kuard successfully rolled out
```

You can see the old and new ReplicaSets managed by the deployment along with the images being used. Both the old and new ReplicaSets are kept around in case you want to roll back:

```
$ kubectl get replicaset -o wide
```

NAME	DESIRED	CURRENT	READY	...	IMAGE(S)	...
kuard-1128242161	0	0	0	...	gcr.io/kuar-demo/	...
kuard-1128635377	3	3	3	...	gcr.io/kuar-demo/	...

If you are in the middle of a rollout and you want to temporarily pause it for some reason (e.g., if you start seeing weird behavior in your system and you want to investigate), you can use the `pause` command:

```
$ kubectl rollout pause deployments kuard
deployment "kuard" paused
```

If, after investigation, you believe the rollout can safely proceed, you can use the `resume` command to start up where you left off:

```
$ kubectl rollout resume deployments kuard
deployment "kuard" resumed
```

Rollout History

Kubernetes deployments maintain a history of rollouts, which can be useful both for understanding the previous state of the deployment and to roll back to a specific version.

You can see the deployment history by running:

```
$ kubectl rollout history deployment kuard
```

```
deployment.extensions/kuard
REVISION  CHANGE-CAUSE
1         <none>
2         Update to green kuard
```

The revision history is given in oldest to newest order. A unique revision number is incremented for each new rollout. So far we have two: the initial deployment, and the update of the image to `kuard:1.9.10`.

If you are interested in more details about a particular revision, you can add the `--revision` flag to view details about that specific revision:

```
$ kubectl rollout history deployment kuard --revision=2

deployment.extensions/kuard with revision #2
Pod Template:
  Labels:      pod-template-hash=54b74ddcd4
              run=kuard
  Annotations: kubernetes.io/change-cause: Update to green kuard
  Containers:
    kuard:
      Image:      gcr.io/kuar-demo/kuard-amd64:green
      Port:       <none>
      Host Port:  <none>
      Environment: <none>
      Mounts:     <none>
      Volumes:    <none>
```

Let's do one more update for this example. Update the kuard version back to blue by modifying the container version number and updating the change-cause annotation. Apply it with `kubectl apply`. Our history should now have three entries:

```
$ kubectl rollout history deployment kuard

deployment.extensions/kuard
REVISION  CHANGE-CAUSE
1          <none>
2          Update to green kuard
3          Update to blue kuard
```

Let's say there is an issue with the latest release and you want to roll back while you investigate. You can simply undo the last rollout:

```
$ kubectl rollout undo deployments kuard
deployment "kuard" rolled back
```

The `undo` command works regardless of the stage of the rollout. You can undo both partially completed and fully completed rollouts. An undo of a rollout is actually simply a rollout in reverse (e.g., from `v2` to `v1`, instead of from `v1` to `v2`), and all of the same policies that control the rollout strategy apply to the undo strategy as well. You can see the Deployment object simply adjusts the desired replica counts in the managed ReplicaSets:

```
$ kubectl get replicaset -o wide
```

NAME	DESIRED	CURRENT	READY	...	IMAGE(S)	...
kuard-1128242161	0	0	0	...	gcr.io/kuar-demo/	...
kuard-1570155864	0	0	0	...	gcr.io/kuar-demo/	...
kuard-2738859366	3	3	3	...	gcr.io/kuar-demo/	...



When using declarative files to control your production systems, you want to, as much as possible, ensure that the checked-in manifests match what is actually running in your cluster. When you do a `kubectl rollout undo` you are updating the production state in a way that isn't reflected in your source control.

An alternative (and perhaps preferred) way to undo a rollout is to revert your YAML file and `kubectl apply` the previous version. In this way, your “change tracked configuration” more closely tracks what is really running in your cluster.

Let's look at our deployment history again:

```
$ kubectl rollout history deployment kuard
deployment.extensions/kuard
REVISION  CHANGE-CAUSE
1          <none>
3          Update to blue kuard
4          Update to green kuard
```

Revision 2 is missing! It turns out that when you roll back to a previous revision, the deployment simply reuses the template and rennumbers it so that it is the latest revision. What was revision 2 before is now reordered into revision 4.

We previously saw that you can use the `kubectl rollout undo` command to roll back to a previous version of a deployment. Additionally, you can roll back to a specific revision in the history using the `--to-revision` flag:

```
$ kubectl rollout undo deployments kuard --to-revision=3
deployment "kuard" rolled back
$ kubectl rollout history deployment kuard
deployment.extensions/kuard
REVISION  CHANGE-CAUSE
1          <none>
4          Update to green kuard
5          Update to blue kuard
```

Again, the `undo` took revision 3, applied it, and renumbered it as revision 5.

Specifying a revision of `0` is a shorthand way of specifying the previous revision. In this way, `kubectl rollout undo` is equivalent to `kubectl rollout undo --to-revision=0`.

By default, the complete revision history of a deployment is kept attached to the Deployment object itself. Over time (e.g., years) this history can grow fairly large, so it is recommended that if you have deployments that you expect to keep around for a long time you set a maximum history size for the deployment revision history, to limit the total size of the Deployment object. For example, if you do a daily update

you may limit your revision history to 14, to keep a maximum of 2 weeks' worth of revisions (if you don't expect to need to roll back beyond 2 weeks).

To accomplish this, use the `revisionHistoryLimit` property in the deployment specification:

```
...
spec:
  # We do daily rollouts, limit the revision history to two weeks of
  # releases as we don't expect to roll back beyond that.
  revisionHistoryLimit: 14
...
```

Deployment Strategies

When it comes time to change the version of software implementing your service, a Kubernetes deployment supports two different rollout strategies:

- `Recreate`
- `RollingUpdate`

Recreate Strategy

The `Recreate` strategy is the simpler of the two rollout strategies. It simply updates the `ReplicaSet` it manages to use the new image and terminates all of the Pods associated with the deployment. The `ReplicaSet` notices that it no longer has any replicas, and re-creates all Pods using the new image. Once the Pods are re-created, they are running the new version.

While this strategy is fast and simple, it has one major drawback—it is potentially catastrophic, and will almost certainly result in some site downtime. Because of this, the `Recreate` strategy should only be used for test deployments where a service is not user-facing and a small amount of downtime is acceptable.

RollingUpdate Strategy

The `RollingUpdate` strategy is the generally preferable strategy for any user-facing service. While it is slower than `Recreate`, it is also significantly more sophisticated and robust. Using `RollingUpdate`, you can roll out a new version of your service while it is still receiving user traffic, without any downtime.

As you might infer from the name, the `RollingUpdate` strategy works by updating a few Pods at a time, moving incrementally until all of the Pods are running the new version of your software.

Managing multiple versions of your service

Importantly, this means that for a period of time, both the new and the old version of your service will be receiving requests and serving traffic. This has important implications for how you build your software. Namely, it is critically important that each version of your software, and all of its clients, is capable of talking interchangeably with both a slightly older and a slightly newer version of your software.

As an example of why this is important, consider the following scenario:

You are in the middle of rolling out your frontend software; half of your servers are running version 1 and half are running version 2. A user makes an initial request to your service and downloads a client-side JavaScript library that implements your UI. This request is serviced by a version 1 server and thus the user receives the version 1 client library. This client library runs in the user's browser and makes subsequent API requests to your service. These API requests happen to be routed to a version 2 server; thus, version 1 of your JavaScript client library is talking to version 2 of your API server. If you haven't ensured compatibility between these versions, your application won't function correctly.

At first, this might seem like an extra burden. But in truth, you always had this problem; you may just not have noticed. Concretely, a user can make a request at time t just before you initiate an update. This request is serviced by a version 1 server. At t_1 you update your service to version 2. At t_2 the version 1 client code running on the user's browser runs and hits an API endpoint being operated by a version 2 server. No matter how you update your software, you have to maintain backward and forward compatibility for reliable updates. The nature of the RollingUpdate strategy simply makes it more clear and explicit that this is something to think about.

Note that this doesn't just apply to JavaScript clients—the same thing is true of client libraries that are compiled into other services that make calls to your service. Just because you updated doesn't mean they have updated their client libraries. This sort of backward compatibility is critical to decoupling your service from systems that depend on your service. If you don't formalize your APIs and decouple yourself, you are forced to carefully manage your rollouts with all of the other systems that call into your service. This kind of tight coupling makes it extremely hard to produce the necessary agility to be able to push out new software every week, let alone every hour or every day. In the decoupled architecture shown in [Figure 10-1](#), the frontend is isolated from the backend via an API contract and a load balancer, whereas in the coupled architecture, a thick client compiled into the frontend is used to connect directly to the backends.

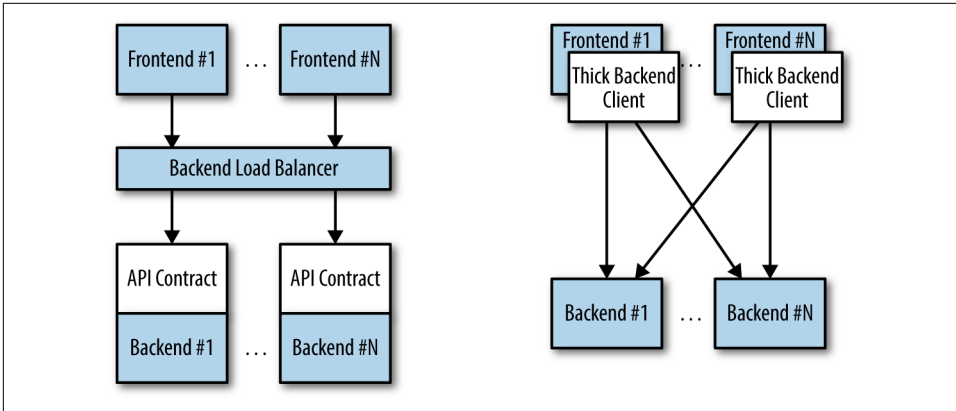

Figure 10-1. Diagrams of both decoupled (left) and coupled (right) application architectures

Configuring a rolling update

RollingUpdate is a fairly generic strategy; it can be used to update a variety of applications in a variety of settings. Consequently, the rolling update itself is quite configurable; you can tune its behavior to suit your particular needs. There are two parameters you can use to tune the rolling update behavior: `maxUnavailable` and `maxSurge`.

The `maxUnavailable` parameter sets the maximum number of Pods that can be unavailable during a rolling update. It can either be set to an absolute number (e.g., 3, meaning a maximum of three Pods can be unavailable) or to a percentage (e.g., 20%, meaning a maximum of 20% of the desired number of replicas can be unavailable).

Generally speaking, using a percentage is a good approach for most services, since the value is correctly applicable regardless of the desired number of replicas in the deployment. However, there are times when you may want to use an absolute number (e.g., limiting the maximum unavailable Pods to one).

At its core, the `maxUnavailable` parameter helps tune how quickly a rolling update proceeds. For example, if you set `maxUnavailable` to 50%, then the rolling update will immediately scale the old ReplicaSet down to 50% of its original size. If you have four replicas, it will scale it down to two replicas. The rolling update will then replace the removed Pods by scaling the new ReplicaSet up to two replicas, for a total of four replicas (two old, two new). It will then scale the old ReplicaSet down to zero replicas, for a total size of two new replicas. Finally, it will scale the new ReplicaSet up to four replicas, completing the rollout. Thus, with `maxUnavailable` set to 50%, our rollout completes in four steps, but with only 50% of our service capacity at times.

Consider what happens if we instead set `maxUnavailable` to 25%. In this situation, each step is only performed with a single replica at a time and thus it takes twice as many steps for the rollout to complete, but availability only drops to a minimum of 75% during the rollout. This illustrates how `maxUnavailable` allows us to trade rollout speed for availability.



The observant among you will note that the `Recreate` strategy is identical to the `RollingUpdate` strategy with `maxUnavailable` set to 100%.

Using reduced capacity to achieve a successful rollout is useful either when your service has cyclical traffic patterns (e.g., much less traffic at night) or when you have limited resources, so scaling to larger than the current maximum number of replicas isn't possible.

However, there are situations where you don't want to fall below 100% capacity, but you are willing to temporarily use additional resources in order to perform a rollout. In these situations, you can set the `maxUnavailable` parameter to 0%, and instead control the rollout using the `maxSurge` parameter. Like `maxUnavailable`, `maxSurge` can be specified either as a specific number or a percentage.

The `maxSurge` parameter controls how many extra resources can be created to achieve a rollout. To illustrate how this works, imagine we have a service with 10 replicas. We set `maxUnavailable` to 0 and `maxSurge` to 20%. The first thing the rollout will do is scale the new `ReplicaSet` up to 2 replicas, for a total of 12 (120%) in the service. It will then scale the old `ReplicaSet` down to 8 replicas, for a total of 10 (8 old, 2 new) in the service. This process proceeds until the rollout is complete. At any time, the capacity of the service is guaranteed to be at least 100% and the maximum extra resources used for the rollout are limited to an additional 20% of all resources.



Setting `maxSurge` to 100% is equivalent to a blue/green deployment. The deployment controller first scales the new version up to 100% of the old version. Once the new version is healthy, it immediately scales the old version down to 0%.

Slowing Rollouts to Ensure Service Health

The purpose of a staged rollout is to ensure that the rollout results in a healthy, stable service running the new software version. To do this, the deployment controller always waits until a Pod reports that it is ready before moving on to updating the next Pod.



The deployment controller examines the Pod's status as determined by its readiness checks. Readiness checks are part of the Pod's health probes, and they are described in detail in [Chapter 5](#). If you want to use deployments to reliably roll out your software, you *have* to specify readiness health checks for the containers in your Pod. Without these checks, the deployment controller is running blind.

Sometimes, however, simply noticing that a Pod has become ready doesn't give you sufficient confidence that the Pod actually is behaving correctly. Some error conditions only occur after a period of time. For example, you could have a serious memory leak that takes a few minutes to show up, or you could have a bug that is only triggered by 1% of all requests. In most real-world scenarios, you want to wait a period of time to have high confidence that the new version is operating correctly before you move on to updating the next Pod.

For deployments, this time to wait is defined by the `minReadySeconds` parameter:

```
...
spec:
  minReadySeconds: 60
...
```

Setting `minReadySeconds` to 60 indicates that the deployment must wait for 60 seconds *after* seeing a Pod become healthy before moving on to updating the next Pod.

In addition to waiting a period of time for a Pod to become healthy, you also want to set a timeout that limits how long the system will wait. Suppose, for example, the new version of your service has a bug and immediately deadlocks. It will never become ready, and in the absence of a timeout, the deployment controller will stall your rollout forever.

The correct behavior in such a situation is to time out the rollout. This in turn marks the rollout as failed. This failure status can be used to trigger alerting that can indicate to an operator that there is a problem with the rollout.



At first blush, timing out a rollout might seem like an unnecessary complication. However, increasingly, things like rollouts are being triggered by fully automated systems with little to no human involvement. In such a situation, timing out becomes a critical exception, which can either trigger an automated rollback of the release or create a ticket/event that triggers human intervention.

To set the timeout period, the deployment parameter `progressDeadlineSeconds` is used:

```

...
spec:
  progressDeadlineSeconds: 600
...

```

This example sets the progress deadline to 10 minutes. If any particular stage in the rollout fails to progress in 10 minutes, then the deployment is marked as failed, and all attempts to move the deployment forward are halted.

It is important to note that this timeout is given in terms of deployment *progress*, not the overall length of a deployment. In this context, progress is defined as any time the deployment creates or deletes a Pod. When that happens, the timeout clock is reset to zero. [Figure 10-2](#) is an illustration of the deployment lifecycle.

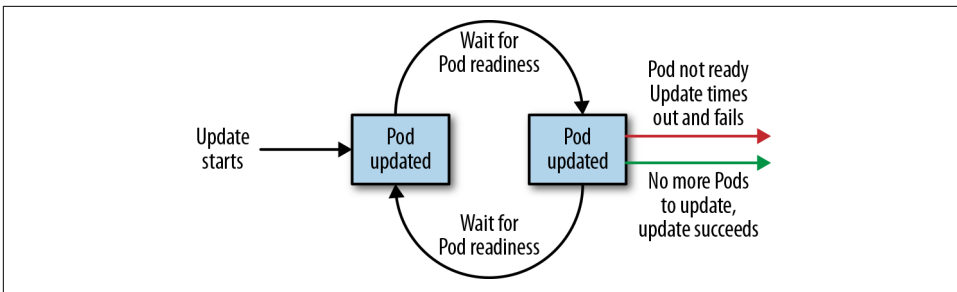

Figure 10-2. The Kubernetes deployment lifecycle

Deleting a Deployment

If you ever want to delete a deployment, you can do it either with the imperative command:

```
$ kubectl delete deployments kuard
```

or using the declarative YAML file we created earlier:

```
$ kubectl delete -f kuard-deployment.yaml
```

In either case, by default, deleting a deployment deletes the entire service. It will delete not just the deployment, but also any ReplicaSets being managed by the deployment, as well as any Pods being managed by the ReplicaSets. As with ReplicaSets, if this is not the desired behavior, you can use the `--cascade=false` flag to exclusively delete the Deployment object.

Monitoring a Deployment

When it comes to a deployment, it is important to note that if it fails to make progress after a certain amount of time, the deployment will time out. When this happens, the status of the deployment will transition to a failed state. This status can be

obtained from the `status.conditions` array, where there will be a `Condition` whose `Type` is `Progressing` and whose `Status` is `False`. A deployment in such a state has failed and will not progress further. To set how long the deployment controller should wait before transitioning into this state, use the `spec.progressDeadlineSeconds` field.

Summary

At the end of the day, the primary goal of Kubernetes is to make it easy for you to build and deploy reliable distributed systems. This means not just instantiating the application once, but managing the regularly scheduled rollout of new versions of that software service. Deployments are a critical piece of reliable rollouts and rollout management for your services.

DaemonSets

Deployments and ReplicaSets are generally about creating a service (e.g., a web server) with multiple replicas for redundancy. But that is not the only reason you may want to replicate a set of Pods within a cluster. Another reason to replicate a set of Pods is to schedule a single Pod on every node within the cluster. Generally, the motivation for replicating a Pod to every node is to land some sort of agent or daemon on each node, and the Kubernetes object for achieving this is the DaemonSet.

A DaemonSet ensures a copy of a Pod is running across a set of nodes in a Kubernetes cluster. DaemonSets are used to deploy system daemons such as log collectors and monitoring agents, which typically must run on every node. DaemonSets share similar functionality with ReplicaSets; both create Pods that are expected to be long-running services and ensure that the desired state and the observed state of the cluster match.

Given the similarities between DaemonSets and ReplicaSets, it's important to understand when to use one over the other. ReplicaSets should be used when your application is completely decoupled from the node and you can run multiple copies on a given node without special consideration. DaemonSets should be used when a single copy of your application must run on all or a subset of the nodes in the cluster.

You should generally not use scheduling restrictions or other parameters to ensure that Pods do not colocate on the same node. If you find yourself wanting a single Pod per node, then a DaemonSet is the correct Kubernetes resource to use. Likewise, if you find yourself building a homogeneous replicated service to serve user traffic, then a ReplicaSet is probably the right Kubernetes resource to use.

You can use labels to run DaemonSet Pods on specific nodes; for example, you may want to run specialized intrusion-detection software on nodes that are exposed to the edge network.

You can also use DaemonSets to install software on nodes in a cloud-based cluster. For many cloud services, an upgrade or scaling of a cluster can delete and/or recreate new virtual machines. This dynamic *immutable infrastructure* approach can cause problems if you want (or are required by central IT) to have specific software on every node. To ensure that specific software is installed on every machine despite upgrades and scale events, a DaemonSet is the right approach. You can even mount the host filesystem and run scripts that install RPM/DEB packages onto the host operating system. In this way, you can have a cloud-native cluster that still meets the enterprise requirements of your IT department.

DaemonSet Scheduler

By default a DaemonSet will create a copy of a Pod on every node unless a node selector is used, which will limit eligible nodes to those with a matching set of labels. DaemonSets determine which node a Pod will run on at Pod creation time by specifying the `nodeName` field in the Pod spec. As a result, Pods created by DaemonSets are ignored by the Kubernetes scheduler.

Like ReplicaSets, DaemonSets are managed by a reconciliation control loop that measures the desired state (a Pod is present on all nodes) with the observed state (is the Pod present on a particular node?). Given this information, the DaemonSet controller creates a Pod on each node that doesn't currently have a matching Pod.

If a new node is added to the cluster, then the DaemonSet controller notices that it is missing a Pod and adds the Pod to the new node.



DaemonSets and ReplicaSets are a great demonstration of the value of Kubernetes's decoupled architecture. It might seem that the right design would be for a ReplicaSet to own the Pods it manages, and for Pods to be subresources of a ReplicaSet. Likewise, the Pods managed by a DaemonSet would be subresources of that DaemonSet. However, this kind of encapsulation would require that tools for dealing with Pods be written two different times, once for DaemonSets and once for ReplicaSets. Instead, Kubernetes uses a decoupled approach where Pods are top-level objects. This means that every tool you have learned for introspecting Pods in the context of ReplicaSets (e.g., `kubectl logs <pod-name>`) is equally applicable to Pods created by DaemonSets.

Creating DaemonSets

DaemonSets are created by submitting a DaemonSet configuration to the Kubernetes API server. The DaemonSet in [Example 11-1](#) will create a `fluentd` logging agent on every node in the target cluster.

Example 11-1. *fluentd.yaml*

```
apiVersion: extensions/v1beta1
kind: DaemonSet
metadata:
  name: fluentd
  labels:
    app: fluentd
spec:
  template:
    metadata:
      labels:
        app: fluentd
    spec:
      containers:
        - name: fluentd
          image: fluent/fluentd:v0.14.10
          resources:
            limits:
              memory: 200Mi
            requests:
              cpu: 100m
              memory: 200Mi
          volumeMounts:
            - name: varlog
              mountPath: /var/log
            - name: varlibdockercontainers
              mountPath: /var/lib/docker/containers
              readOnly: true
      terminationGracePeriodSeconds: 30
      volumes:
        - name: varlog
          hostPath:
            path: /var/log
        - name: varlibdockercontainers
          hostPath:
            path: /var/lib/docker/containers
```

DaemonSets require a unique name across all DaemonSets in a given Kubernetes namespace. Each DaemonSet must include a Pod template spec, which will be used to create Pods as needed. This is where the similarities between ReplicaSets and DaemonSets end. Unlike ReplicaSets, DaemonSets will create Pods on every node in the cluster by default unless a node selector is used.

Once you have a valid DaemonSet configuration in place, you can use the `kubectl apply` command to submit the DaemonSet to the Kubernetes API. In this section we will create a DaemonSet to ensure the `fluentd` HTTP server is running on every node in our cluster:

```
$ kubectl apply -f fluentd.yaml
daemonset "fluentd" created
```

Once the `fluentd` DaemonSet has been successfully submitted to the Kubernetes API, you can query its current state using the `kubectl describe` command:

```
$ kubectl describe daemonset fluentd
Name:          fluentd
Image(s):      fluent/fluentd:v0.14.10
Selector:      app=fluentd
Node-Selector: <none>
Labels:        app=fluentd
Desired Number of Nodes Scheduled: 3
Current Number of Nodes Scheduled: 3
Number of Nodes Misscheduled: 0
Pods Status:   3 Running / 0 Waiting / 0 Succeeded / 0 Failed
```

This output indicates a `fluentd` Pod was successfully deployed to all three nodes in our cluster. We can verify this using the `kubectl get pods` command with the `-o` flag to print the nodes where each `fluentd` Pod was assigned:

```
$ kubectl get pods -o wide
NAME                AGE    NODE
fluentd-1q6c6       13m    k0-default-pool-35609c18-z7tb
fluentd-mwi7h       13m    k0-default-pool-35609c18-ydae
fluentd-zr6l7       13m    k0-default-pool-35609c18-pol3
```

With the `fluentd` DaemonSet in place, adding a new node to the cluster will result in a `fluentd` Pod being deployed to that node automatically:

```
$ kubectl get pods -o wide
NAME                AGE    NODE
fluentd-1q6c6       13m    k0-default-pool-35609c18-z7tb
fluentd-mwi7h       13m    k0-default-pool-35609c18-ydae
fluentd-oipmq       43s    k0-default-pool-35609c18-0xnl
fluentd-zr6l7       13m    k0-default-pool-35609c18-pol3
```

This is exactly the behavior you want when managing logging daemons and other cluster-wide services. No action was required from our end; this is how the Kubernetes DaemonSet controller reconciles its observed state with our desired state.

Limiting DaemonSets to Specific Nodes

The most common use case for DaemonSets is to run a Pod across every node in a Kubernetes cluster. However, there are some cases where you want to deploy a Pod to only a subset of nodes. For example, maybe you have a workload that requires a GPU or access to fast storage only available on a subset of nodes in your cluster. In cases like these, node labels can be used to tag specific nodes that meet workload requirements.

Adding Labels to Nodes

The first step in limiting DaemonSets to specific nodes is to add the desired set of labels to a subset of nodes. This can be achieved using the `kubectl label` command.

The following command adds the `ssd=true` label to a single node:

```
$ kubectl label nodes k0-default-pool-35609c18-z7tb ssd=true
node "k0-default-pool-35609c18-z7tb" labeled
```

Just like with other Kubernetes resources, listing nodes without a label selector returns all nodes in the cluster:

```
$ kubectl get nodes
NAME                                STATUS    AGE
k0-default-pool-35609c18-0xn1      Ready    23m
k0-default-pool-35609c18-pol3      Ready    1d
k0-default-pool-35609c18-ydae      Ready    1d
k0-default-pool-35609c18-z7tb      Ready    1d
```

Using a label selector, we can filter nodes based on labels. To list only the nodes that have the `ssd` label set to `true`, use the `kubectl get nodes` command with the `--selector` flag:

```
$ kubectl get nodes --selector ssd=true
NAME                                STATUS    AGE
k0-default-pool-35609c18-z7tb      Ready    1d
```

Node Selectors

Node selectors can be used to limit what nodes a Pod can run on in a given Kubernetes cluster. Node selectors are defined as part of the Pod spec when creating a DaemonSet. The DaemonSet configuration in [Example 11-2](#) limits NGINX to running only on nodes with the `ssd=true` label set.

Example 11-2. nginx-fast-storage.yaml

```
apiVersion: extensions/v1beta1
kind: "DaemonSet"
metadata:
  labels:
    app: nginx
    ssd: "true"
  name: nginx-fast-storage
spec:
  template:
    metadata:
      labels:
        app: nginx
        ssd: "true"
    spec:
```

```
nodeSelector:
  ssd: "true"
containers:
- name: nginx
  image: nginx:1.10.0
```

Let's see what happens when we submit the `nginx-fast-storage` DaemonSet to the Kubernetes API:

```
$ kubectl apply -f nginx-fast-storage.yaml
daemonset "nginx-fast-storage" created
```

Since there is only one node with the `ssd=true` label, the `nginx-fast-storage` Pod will only run on that node:

```
$ kubectl get pods -o wide
NAME                                STATUS    NODE
nginx-fast-storage-7b90t            Running  k0-default-pool-35609c18-z7tb
```

Adding the `ssd=true` label to additional nodes will cause the `nginx-fast-storage` Pod to be deployed on those nodes. The inverse is also true: if a required label is removed from a node, the Pod will be removed by the DaemonSet controller.



Removing labels from a node that are required by a DaemonSet's node selector will cause the Pod being managed by that DaemonSet to be removed from the node.

Updating a DaemonSet

DaemonSets are great for deploying services across an entire cluster, but what about upgrades? Prior to Kubernetes 1.6, the only way to update Pods managed by a DaemonSet was to update the DaemonSet and then manually delete each Pod that was managed by the DaemonSet so that it would be re-created with the new configuration. With the release of Kubernetes 1.6, DaemonSets gained an equivalent to the Deployment object that manages a DaemonSet rollout inside the cluster.

Rolling Update of a DaemonSet

DaemonSets can be rolled out using the same `RollingUpdate` strategy that deployments use. You can configure the update strategy using the `spec.updateStrategy.type` field, which should have the value `RollingUpdate`. When a DaemonSet has an update strategy of `RollingUpdate`, any change to the `spec.template` field (or subfields) in the DaemonSet will initiate a rolling update.

As with rolling updates of deployments (see [Chapter 10](#)), the `RollingUpdate` strategy gradually updates members of a `DaemonSet` until all of the Pods are running the new configuration. There are two parameters that control the rolling update of a `DaemonSet`:

- `spec.minReadySeconds`, which determines how long a Pod must be “ready” before the rolling update proceeds to upgrade subsequent Pods
- `spec.updateStrategy.rollingUpdate.maxUnavailable`, which indicates how many Pods may be simultaneously updated by the rolling update

You will likely want to set `spec.minReadySeconds` to a reasonably long value, for example 30–60 seconds, to ensure that your Pod is truly healthy before the rollout proceeds.

The setting for `spec.updateStrategy.rollingUpdate.maxUnavailable` is more likely to be application-dependent. Setting it to 1 is a safe, general-purpose strategy, but it also takes a while to complete the rollout (number of nodes \times `minReadySeconds`). Increasing the maximum unavailability will make your rollout move faster, but increases the “blast radius” of a failed rollout. The characteristics of your application and cluster environment dictate the relative values of speed versus safety. A good approach might be to set `maxUnavailable` to 1 and only increase it if users or administrators complain about `DaemonSet` rollout speed.

Once a rolling update has started, you can use the `kubectl rollout` commands to see the current status of a `DaemonSet` rollout.

For example, `kubectl rollout status daemonSets my-daemon-set` will show the current rollout status of a `DaemonSet` named `my-daemon-set`.

Deleting a DaemonSet

Deleting a `DaemonSet` is pretty straightforward using the `kubectl delete` command. Just be sure to supply the correct name of the `DaemonSet` you would like to delete:

```
$ kubectl delete -f fluentd.yaml
```



Deleting a `DaemonSet` will also delete all the Pods being managed by that `DaemonSet`. Set the `--cascade` flag to `false` to ensure only the `DaemonSet` is deleted and not the Pods.

Summary

DaemonSets provide an easy-to-use abstraction for running a set of Pods on every node in a Kubernetes cluster, or, if the case requires it, on a subset of nodes based on labels. The DaemonSet provides its own controller and scheduler to ensure key services like monitoring agents are always up and running on the right nodes in your cluster.

For some applications, you simply want to schedule a certain number of replicas; you don't really care where they run as long as they have sufficient resources and distribution to operate reliably. However, there is a different class of applications, like agents and monitoring applications, that need to be present on every machine in a cluster to function properly. These DaemonSets aren't really traditional serving applications, but rather add additional capabilities and features to the Kubernetes cluster itself. Because the DaemonSet is an active declarative object managed by a controller, it makes it easy to declare your intent that an agent run on every machine without explicitly placing it on every machine. This is especially useful in the context of an autoscaled Kubernetes cluster where nodes may constantly be coming and going without user intervention. In such cases, the DaemonSet automatically adds the proper agents to each node as it is added to the cluster by the autoscaler.

So far we have focused on long-running processes such as databases and web applications. These types of workloads run until either they are upgraded or the service is no longer needed. While long-running processes make up the large majority of workloads that run on a Kubernetes cluster, there is often a need to run short-lived, one-off tasks. The Job object is made for handling these types of tasks.

A job creates Pods that run until successful termination (i.e., exit with 0). In contrast, a regular Pod will continually restart regardless of its exit code. Jobs are useful for things you only want to do once, such as database migrations or batch jobs. If run as a regular Pod, your database migration task would run in a loop, continually repopulating the database after every exit.

In this chapter we'll explore the most common job patterns afforded by Kubernetes. We will also leverage these patterns in real-life scenarios.

The Job Object

The Job object is responsible for creating and managing Pods defined in a template in the job specification. These Pods generally run until successful completion. The Job object coordinates running a number of Pods in parallel.

If the Pod fails before a successful termination, the job controller will create a new Pod based on the Pod template in the job specification. Given that Pods have to be scheduled, there is a chance that your job will not execute if the required resources are not found by the scheduler. Also, due to the nature of distributed systems there is a small chance, during certain failure scenarios, that duplicate Pods will be created for a specific task.

Job Patterns

Jobs are designed to manage batch-like workloads where work items are processed by one or more Pods. By default, each job runs a single Pod once until successful termination. This job pattern is defined by two primary attributes of a job, namely the number of job completions and the number of Pods to run in parallel. In the case of the “run once until completion” pattern, the `completions` and `parallelism` parameters are set to 1.

Table 12-1 highlights job patterns based on the combination of `completions` and `parallelism` for a job configuration.

Table 12-1. Job patterns

Type	Use case	Behavior	completions	parallelism
One shot	Database migrations	A single Pod running once until successful termination	1	1
Parallel fixed completions	Multiple Pods processing a set of work in parallel	One or more Pods running one or more times until reaching a fixed completion count	1+	1+
Work queue: parallel jobs	Multiple Pods processing from a centralized work queue	One or more Pods running once until successful termination	1	2+

One Shot

One-shot jobs provide a way to run a single Pod once until successful termination. While this may sound like an easy task, there is some work involved in pulling this off. First, a Pod must be created and submitted to the Kubernetes API. This is done using a Pod template defined in the job configuration. Once a job is up and running, the Pod backing the job must be monitored for successful termination. A job can fail for any number of reasons, including an application error, an uncaught exception during runtime, or a node failure before the job has a chance to complete. In all cases, the job controller is responsible for recreating the Pod until a successful termination occurs.

There are multiple ways to create a one-shot job in Kubernetes. The easiest is to use the `kubectl` command-line tool:

```
$ kubectl run -i oneshot \
  --image=gcr.io/kuar-demo/kuard-amd64:blue \
  --restart=OnFailure \
  -- --keygen-enable \
  --keygen-exit-on-complete \
  --keygen-num-to-gen 10
```

...

```
(ID 0) Workload starting
(ID 0 1/10) Item done: SHA256:nAsUsG54XoKRkJwyN+0ShkUPKew3mwq70Cc
(ID 0 2/10) Item done: SHA256:HVKX1ANns6SgF/er1lyo+ZCdnB8geFGt0/8
(ID 0 3/10) Item done: SHA256:irjCLRov3mTT0P0JfsvUyhKRQ1TdGR8H1jg
(ID 0 4/10) Item done: SHA256:nbQAIIVY/yrhmEGk3Ui2sAHuxb/o6mY00qRk
(ID 0 5/10) Item done: SHA256:CCpBoXNLXOMQvR2v38yqimXGAa/w2Tym+aI
(ID 0 6/10) Item done: SHA256:wEY2TTIDz4ATjcr1iimxavCzZzNjRmb0Qp8
(ID 0 7/10) Item done: SHA256:t3JSrCt7sQweBgqG5CrbMoBulwk4lFDwiTI
(ID 0 8/10) Item done: SHA256:E84/Vze7KKyjCh90Zh02MkXJGoty9PhaCec
(ID 0 9/10) Item done: SHA256:U0mYex79qqbI1MhcIFG4hDnGKonlsij2k3s
(ID 0 10/10) Item done: SHA256:WCR8wIGOFag84Bs8f/9QHukqF+0mEnCADY
(ID 0) Workload exiting
```

There are some things to note here:

- The `-i` option to `kubectl` indicates that this is an interactive command. `kubectl` will wait until the job is running and then show the log output from the first (and in this case only) Pod in the job.
- `--restart=OnFailure` is the option that tells `kubectl` to create a Job object.
- All of the options after `--` are command-line arguments to the container image. These instruct our test server (`kuard`) to generate 10 4,096-bit SSH keys and then exit.
- Your output may not match this exactly. `kubectl` often misses the first couple of lines of output with the `-i` option.

After the job has completed, the Job object and related Pod are still around. This is so that you can inspect the log output. Note that this job won't show up in `kubectl get jobs` unless you pass the `-a` flag. Without this flag, `kubectl` hides completed jobs. Delete the job before continuing:

```
$ kubectl delete jobs oneshot
```

The other option for creating a one-shot job is using a configuration file, as shown in [Example 12-1](#).

Example 12-1. job-oneshot.yaml

```
apiVersion: batch/v1
kind: Job
metadata:
  name: oneshot
spec:
  template:
    spec:
      containers:
      - name: kuard
        image: gcr.io/kuar-demo/kuard-amd64:blue
        imagePullPolicy: Always
```

```

  args:
  - "--keygen-enable"
  - "--keygen-exit-on-complete"
  - "--keygen-num-to-gen=10"
restartPolicy: OnFailure

```

Submit the job using the `kubectl apply` command:

```

$ kubectl apply -f job-oneshot.yaml
job "oneshot" created

```

Then describe the oneshot job:

```

$ kubectl describe jobs oneshot

Name:          oneshot
Namespace:     default
Image(s):      gcr.io/kuar-demo/kuard-amd64:blue
Selector:      controller-uid=cf87484b-e664-11e6-8222-42010a8a007b
Parallelism:   1
Completions:   1
Start Time:    Sun, 29 Jan 2017 12:52:13 -0800
Labels:        Job=oneshot
Pods Statuses: 0 Running / 1 Succeeded / 0 Failed
No volumes.
Events:
  ... Reason          Message
  ... -----          -
  ... SuccessfulCreate Created pod: oneshot-4kfdt

```

You can view the results of the job by looking at the logs of the Pod that was created:

```

$ kubectl logs oneshot-4kfdt

...
Serving on :8080
(ID 0) Workload starting
(ID 0 1/10) Item done: SHA256:+r6b4W81DbEjxMcD3LHjU+EIgNLEzbpXITKn8IqhkPI
(ID 0 2/10) Item done: SHA256:mzHewajaY1KA8VluSLOnNMk9fDE5zdn7vvBS5Ne8AxM
(ID 0 3/10) Item done: SHA256:TRtEQHfflJmwkqnNyGgQm/IvXNyKSBIg8c03h0g3one
(ID 0 4/10) Item done: SHA256:tSwPYH/J347il/mgqTxRRdeZcOazEtgZLA8A3/HWbro
(ID 0 5/10) Item done: SHA256:IP8XtguJ6GbWwLHqjKecVfdS96B17nn021I/TNc1j9k
(ID 0 6/10) Item done: SHA256:ZfNxdQvuST/6ZzEVkyxdRG98p73c/5TM99SEbPeRwfc
(ID 0 7/10) Item done: SHA256:tH+CNl/IUl/HUuKdMsq2XEmDQ8oAvmhMO6Iwj8ZE0j0
(ID 0 8/10) Item done: SHA256:3GfsUaALVEHQcGNLB0u4Qd1zqqqJ8j738i5r+I5XwVI
(ID 0 9/10) Item done: SHA256:5wV4L/xEiHSJXwLUT2fHf0SCKM2g3XH3sVtNbgskCXw
(ID 0 10/10) Item done: SHA256:bPqqOonwSbjzLqe9ZuVRmZkz+DBjaNTZ9HwmQhbdWLI
(ID 0) Workload exiting

```

Congratulations, your job has run successfully!



You may have noticed that we didn't specify any labels when creating the Job object. Like with other controllers (DaemonSets, ReplicaSets, deployments, etc.) that use labels to identify a set of Pods, unexpected behaviors can happen if a Pod is reused across objects.

Because jobs have a finite beginning and ending, it is common for users to create many of them. This makes picking unique labels more difficult and more critical. For this reason, the Job object will automatically pick a unique label and use it to identify the Pods it creates. In advanced scenarios (such as swapping out a running job without killing the Pods it is managing), users can choose to turn off this automatic behavior and manually specify labels and selectors.

Pod failure

We just saw how a job can complete successfully. But what happens if something fails? Let's try that out and see what happens.

Let's modify the arguments to `kuard` in our configuration file to cause it to fail out with a nonzero exit code after generating three keys, as shown in [Example 12-2](#).

Example 12-2. job-oneshot-failure1.yaml

```
...
spec:
  template:
    spec:
      containers:
        ...
        args:
        - "--keygen-enable"
        - "--keygen-exit-on-complete"
        - "--keygen-exit-code=1"
        - "--keygen-num-to-gen=3"
...

```

Now launch this with `kubectl apply -f job-oneshot-failure1.yaml`. Let it run for a bit and then look at the Pod status:

```
$ kubectl get pod -a -l job-name=oneshot
```

NAME	READY	STATUS	RESTARTS	AGE
oneshot-3ddk0	0/1	CrashLoopBackOff	4	3m

Here we see that the same Pod has restarted four times. Kubernetes is in `CrashLoopBackOff` for this Pod. It is not uncommon to have a bug someplace that causes a program to crash as soon as it starts. In that case, Kubernetes will wait a bit before

restarting the Pod to avoid a crash loop eating resources on the node. This is all handled local to the node by the kubelet without the job being involved at all.

Kill the job (`kubectl delete jobs oneshot`), and let's try something else. Modify the config file again and change the `restartPolicy` from `OnFailure` to `Never`. Launch this with `kubectl apply -f jobs-oneshot-failure2.yaml`.

If we let this run for a bit and then look at related Pods we'll find something interesting:

```
$ kubectl get pod -l job-name=oneshot -a
```

NAME	READY	STATUS	RESTARTS	AGE
oneshot-0wm49	0/1	Error	0	1m
oneshot-6h9s2	0/1	Error	0	39s
oneshot-hkzw0	1/1	Running	0	6s
oneshot-k5swz	0/1	Error	0	28s
oneshot-m1rdw	0/1	Error	0	19s
oneshot-x157b	0/1	Error	0	57s

What we see is that we have multiple Pods here that have errored out. By setting `restartPolicy: Never` we are telling the kubelet not to restart the Pod on failure, but rather just declare the Pod as failed. The Job object then notices and creates a replacement Pod. If you aren't careful, this'll create a lot of "junk" in your cluster. For this reason, we suggest you use `restartPolicy: OnFailure` so failed Pods are rerun in place.

Clean this up with `kubectl delete jobs oneshot`.

So far we've seen a program fail by exiting with a nonzero exit code. But workers can fail in other ways. Specifically, they can get stuck and not make any forward progress. To help cover this case, you can use liveness probes with jobs. If the liveness probe policy determines that a Pod is dead, it'll be restarted/replaced for you.

Parallelism

Generating keys can be slow. Let's start a bunch of workers together to make key generation faster. We're going to use a combination of the `completions` and `parallelism` parameters. Our goal is to generate 100 keys by having 10 runs of `kuard` with each run generating 10 keys. But we don't want to swamp our cluster, so we'll limit ourselves to only five Pods at a time.

This translates to setting `completions` to 10 and `parallelism` to 5. The config is shown in [Example 12-3](#).

Example 12-3. *job-parallel.yaml*

```
apiVersion: batch/v1
kind: Job
metadata:
  name: parallel
  labels:
    chapter: jobs
spec:
  parallelism: 5
  completions: 10
  template:
    metadata:
      labels:
        chapter: jobs
    spec:
      containers:
      - name: kuard
        image: gcr.io/kuar-demo/kuard-amd64:blue
        imagePullPolicy: Always
        args:
        - "--keygen-enable"
        - "--keygen-exit-on-complete"
        - "--keygen-num-to-gen=10"
      restartPolicy: OnFailure
```

Start it up:

```
$ kubectl apply -f job-parallel.yaml
job "parallel" created
```

Now watch as the Pods come up, do their thing, and exit. New Pods are created until 10 have completed altogether. Here we use the `--watch` flag to have `kubectl` stay around and list changes as they happen:

```
$ kubectl get pods -w
NAME                READY   STATUS    RESTARTS   AGE
parallel-55tlv     1/1     Running   0           5s
parallel-5s7s9     1/1     Running   0           5s
parallel-jp7bj     1/1     Running   0           5s
parallel-lssmn     1/1     Running   0           5s
parallel-qxcxp     1/1     Running   0           5s
NAME                READY   STATUS    RESTARTS   AGE
parallel-jp7bj     0/1     Completed 0           26s
parallel-tzp9n     0/1     Pending   0           0s
parallel-tzp9n     0/1     Pending   0           0s
parallel-tzp9n     0/1     ContainerCreating 0           1s
parallel-tzp9n     1/1     Running   0           1s
parallel-tzp9n     0/1     Completed 0           48s
parallel-x1kmr     0/1     Pending   0           0s
parallel-x1kmr     0/1     Pending   0           0s
parallel-x1kmr     0/1     ContainerCreating 0           0s
```

```

parallel-x1kmr 1/1 Running 0 1s
parallel-5s7s9 0/1 Completed 0 1m
parallel-tprfj 0/1 Pending 0 0s
parallel-tprfj 0/1 Pending 0 0s
parallel-tprfj 0/1 ContainerCreating 0 0s
parallel-tprfj 1/1 Running 0 2s
parallel-x1kmr 0/1 Completed 0 52s
parallel-bgvz5 0/1 Pending 0 0s
parallel-bgvz5 0/1 Pending 0 0s
parallel-bgvz5 0/1 ContainerCreating 0 0s
parallel-bgvz5 1/1 Running 0 2s
parallel-qxcxp 0/1 Completed 0 2m
parallel-xplw2 0/1 Pending 0 1s
parallel-xplw2 0/1 Pending 0 1s
parallel-xplw2 0/1 ContainerCreating 0 1s
parallel-xplw2 1/1 Running 0 3s
parallel-bgvz5 0/1 Completed 0 40s
parallel-55tlv 0/1 Completed 0 2m
parallel-lssmn 0/1 Completed 0 2m

```

Feel free to study the completed jobs and check out their logs to see the fingerprints of the keys they generated. Clean up by deleting the finished Job object with `kubectl delete job parallel`.

Work Queues

A common use case for jobs is to process work from a work queue. In this scenario, some task creates a number of work items and publishes them to a work queue. A worker job can be run to process each work item until the work queue is empty (Figure 12-1).

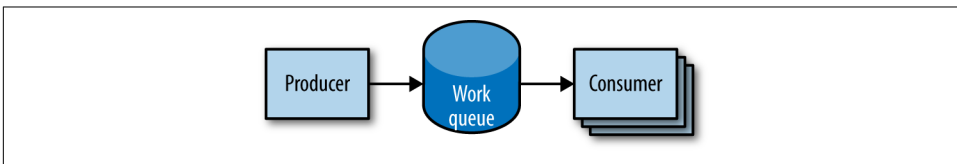

Figure 12-1. Parallel jobs

Starting a work queue

We start by launching a centralized work queue service. `kuard` has a simple memory-based work queue system built in. We will start an instance of `kuard` to act as a coordinator for all the work to be done.

Next, we create a simple `ReplicaSet` to manage a singleton work queue daemon. We are using a `ReplicaSet` to ensure that a new Pod will get created in the face of machine failure, as shown in [Example 12-4](#).

Example 12-4. rs-queue.yaml

```
apiVersion: extensions/v1beta1
kind: ReplicaSet
metadata:
  labels:
    app: work-queue
    component: queue
    chapter: jobs
  name: queue
spec:
  replicas: 1
  template:
    metadata:
      labels:
        app: work-queue
        component: queue
        chapter: jobs
    spec:
      containers:
      - name: queue
        image: "gcr.io/kuar-demo/kuar-amd64:blue"
        imagePullPolicy: Always
```

Run the work queue with the following command:

```
$ kubectl apply -f rs-queue.yaml
```

At this point the work queue daemon should be up and running. Let's use port forwarding to connect to it. Leave this command running in a terminal window:

```
$ QUEUE_POD=$(kubectl get pods -l app=work-queue,component=queue \
-o jsonpath='{.items[0].metadata.name}')
$ kubectl port-forward $QUEUE_POD 8080:8080
Forwarding from 127.0.0.1:8080 -> 8080
Forwarding from [::1]:8080 -> 8080
```

You can open your browser to <http://localhost:8080> and see the kuar interface. Switch to the “MemQ Server” tab to keep an eye on what is going on.

With the work queue server in place, we should expose it using a service. This will make it easy for producers and consumers to locate the work queue via DNS, as [Example 12-5](#) shows.

Example 12-5. service-queue.yaml

```
apiVersion: v1
kind: Service
metadata:
  labels:
    app: work-queue
    component: queue
```



```
chapter: jobs
name: queue
spec:
  ports:
  - port: 8080
    protocol: TCP
    targetPort: 8080
  selector:
    app: work-queue
    component: queue
```

Create the queue service with `kubectl`:

```
$ kubectl apply -f service-queue.yaml
service "queue" created
```

Loading up the queue

We are now ready to put a bunch of work items in the queue. For the sake of simplicity we'll just use `curl` to drive the API for the work queue server and insert a bunch of work items. `curl` will communicate to the work queue through the `kubectl` port-forward we set up earlier, as shown in [Example 12-6](#).

Example 12-6. load-queue.sh

```
# Create a work queue called 'keygen'
curl -X PUT localhost:8080/memq/server/queues/keygen

# Create 100 work items and load up the queue.
for i in work-item-{0..99}; do
  curl -X POST localhost:8080/memq/server/queues/keygen/enqueue \
    -d "$i"
done
```

Run these commands, and you should see 100 JSON objects output to your terminal with a unique message identifier for each work item. You can confirm the status of the queue by looking at the “MemQ Server” tab in the UI, or you can ask the work queue API directly:

```
$ curl 127.0.0.1:8080/memq/server/stats
{
  "kind": "stats",
  "queues": [
    {
      "depth": 100,
      "dequeued": 0,
      "drained": 0,
      "enqueued": 100,
      "name": "keygen"
    }
  ]
}
```

```
    ]  
  }  
}
```

Now we are ready to kick off a job to consume the work queue until it's empty.

Creating the consumer job

This is where things get interesting! `kuard` is also able to act in consumer mode. We can set it up to draw work items from the work queue, create a key, and then exit once the queue is empty, as shown in [Example 12-7](#).

Example 12-7. job-consumers.yaml

```
apiVersion: batch/v1  
kind: Job  
metadata:  
  labels:  
    app: message-queue  
    component: consumer  
    chapter: jobs  
  name: consumers  
spec:  
  parallelism: 5  
  template:  
    metadata:  
      labels:  
        app: message-queue  
        component: consumer  
        chapter: jobs  
    spec:  
      containers:  
      - name: worker  
        image: "gcr.io/kuar-demo/kuard-amd64:blue"  
        imagePullPolicy: Always  
        args:  
        - "--keygen-enable"  
        - "--keygen-exit-on-complete"  
        - "--keygen-memq-server=http://queue:8080/memq/server"  
        - "--keygen-memq-queue=keygen"  
      restartPolicy: OnFailure
```

Here, we are telling the job to start up five Pods in parallel. As the `completions` parameter is unset, we put the job into a worker pool mode. Once the first Pod exits with a zero exit code, the job will start winding down and will not start any new Pods. This means that none of the workers should exit until the work is done and they are all in the process of finishing up.

Now, create the consumers job:

```
$ kubectl apply -f job-consumers.yaml
job "consumers" created
```

Once the job has been created, you can view the Pods backing the job:

```
$ kubectl get pods
NAME                READY   STATUS    RESTARTS   AGE
queue-43s87         1/1    Running   0           5m
consumers-6wjxc     1/1    Running   0           2m
consumers-7l5mh     1/1    Running   0           2m
consumers-hvz42     1/1    Running   0           2m
consumers-pc8hr     1/1    Running   0           2m
consumers-w20cc     1/1    Running   0           2m
```

Note there are five Pods running in parallel. These Pods will continue to run until the work queue is empty. You can watch as it happens in the UI on the work queue server. As the queue empties, the consumer Pods will exit cleanly and the consumers job will be considered complete.

Cleaning up

Using labels, we can clean up all of the stuff we created in this section:

```
$ kubectl delete rs,svc,job -l chapter=jobs
```

CronJobs

Sometimes you want to schedule a job to be run at a certain interval. To achieve this you can declare a CronJob in Kubernetes, which is responsible for creating a new Job object at a particular interval. The declaration of a CronJob looks like:

```
apiVersion: batch/v1beta1
kind: CronJob
metadata:
  name: example-cron
spec:
  # Run every fifth hour
  schedule: "0 */5 * * *"
  jobTemplate:
    spec:
      template:
        spec:
          containers:
            - name: batch-job
              image: my-batch-image
              restartPolicy: OnFailure
```

Note the `spec.schedule` field, which contains the interval for the CronJob in standard cron format.

You can save this file as *cron-job.yaml*, and create the CronJob with `kubectl create -f cron-job.yaml`. If you are interested in the current state of a CronJob, you can use `kubectl describe <cron-job>` to get the details.

Summary

On a single cluster, Kubernetes can handle both long-running workloads such as web applications and short-lived workloads such as batch jobs. The job abstraction allows you to model batch job patterns ranging from simple one-time tasks to parallel jobs that process many items until work has been exhausted.

Jobs are a low-level primitive and can be used directly for simple workloads. However, Kubernetes is built from the ground up to be extensible by higher-level objects. Jobs are no exception; they can easily be used by higher-level orchestration systems to take on more complex tasks.

ConfigMaps and Secrets

It is a good practice to make container images as reusable as possible. The same image should be able to be used for development, staging, and production. It is even better if the same image is general-purpose enough to be used across applications and services. Testing and versioning get riskier and more complicated if images need to be recreated for each new environment. But then how do we specialize the use of that image at runtime?

This is where ConfigMaps and secrets come into play. ConfigMaps are used to provide configuration information for workloads. This can either be fine-grained information (a short string) or a composite value in the form of a file. Secrets are similar to ConfigMaps but focused on making sensitive information available to the workload. They can be used for things like credentials or TLS certificates.

ConfigMaps

One way to think of a ConfigMap is as a Kubernetes object that defines a small filesystem. Another way is as a set of variables that can be used when defining the environment or command line for your containers. The key thing is that the ConfigMap is combined with the Pod right before it is run. This means that the container image and the Pod definition itself can be reused across many apps by just changing the ConfigMap that is used.

Creating ConfigMaps

Let's jump right in and create a ConfigMap. Like many objects in Kubernetes, you can create these in an immediate, imperative way, or you can create them from a manifest on disk. We'll start with the imperative method.

First, suppose we have a file on disk (called *my-config.txt*) that we want to make available to the Pod in question, as shown in [Example 13-1](#).

Example 13-1. my-config.txt

```
# This is a sample config file that I might use to configure an application
parameter1 = value1
parameter2 = value2
```

Next, let's create a ConfigMap with that file. We'll also add a couple of simple key/value pairs here. These are referred to as literal values on the command line:

```
$ kubectl create configmap my-config \
  --from-file=my-config.txt \
  --from-literal=extra-param=extra-value \
  --from-literal=another-param=another-value
```

The equivalent YAML for the ConfigMap object we just created is:

```
$ kubectl get configmaps my-config -o yaml

apiVersion: v1
data:
  another-param: another-value
  extra-param: extra-value
  my-config.txt: |
    # This is a sample config file that I might use to configure an application
    parameter1 = value1
    parameter2 = value2
kind: ConfigMap
metadata:
  creationTimestamp: ...
  name: my-config
  namespace: default
  resourceVersion: "13556"
  selfLink: /api/v1/namespaces/default/configmaps/my-config
  uid: 3641c553-f7de-11e6-98c9-06135271a273
```

As you can see, the ConfigMap is really just some key/value pairs stored in an object. The interesting stuff happens when you try to *use* a ConfigMap.

Using a ConfigMap

There are three main ways to use a ConfigMap:

Filesystem

You can mount a ConfigMap into a Pod. A file is created for each entry based on the key name. The contents of that file are set to the value.

Environment variable

A ConfigMap can be used to dynamically set the value of an environment variable.

Command-line argument

Kubernetes supports dynamically creating the command line for a container based on ConfigMap values.

Let's create a manifest for kuard that pulls all of these together, as shown in [Example 13-2](#).

Example 13-2. kuard-config.yaml

```
apiVersion: v1
kind: Pod
metadata:
  name: kuard-config
spec:
  containers:
    - name: test-container
      image: gcr.io/kuar-demo/kuard-amd64:blue
      imagePullPolicy: Always
      command:
        - "/kuard"
        - "${EXTRA_PARAM}"
      env:
        - name: ANOTHER_PARAM
          valueFrom:
            configMapKeyRef:
              name: my-config
              key: another-param
        - name: EXTRA_PARAM
          valueFrom:
            configMapKeyRef:
              name: my-config
              key: extra-param
      volumeMounts:
        - name: config-volume
          mountPath: /config
  volumes:
    - name: config-volume
      configMap:
        name: my-config
      restartPolicy: Never
```

For the filesystem method, we create a new volume inside the Pod and give it the name `config-volume`. We then define this volume to be a ConfigMap volume and point at the ConfigMap to mount. We have to specify where this gets mounted into the kuard container with a `volumeMount`. In this case we are mounting it at `/config`.

Environment variables are specified with a special `valueFrom` member. This references the `ConfigMap` and the data key to use within that `ConfigMap`.

Command-line arguments build on environment variables. Kubernetes will perform the correct substitution with a special `$(<env-var-name>)` syntax.

Run this Pod, and let's port forward to examine how the app sees the world:

```
$ kubectl apply -f kuard-config.yaml
$ kubectl port-forward kuard-config 8080
```

Now point your browser at <http://localhost:8080>. We can look at how we've injected configuration values into the program in all three ways.

Click the "Server Env" tab on the left. This will show the command line that the app was launched with along with its environment, as shown in [Figure 13-1](#).

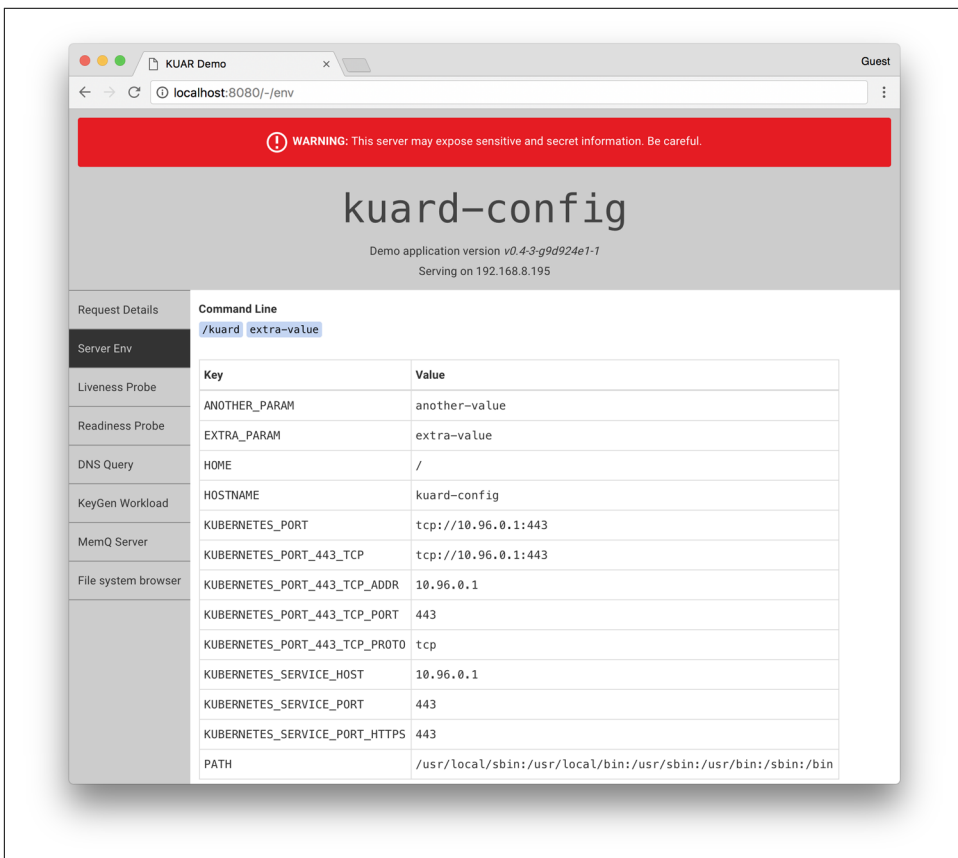

Figure 13-1. kuard showing its environment

Here we can see that we've added two environment variables (ANOTHER_PARAM and EXTRA_PARAM) whose values are set via the ConfigMap. Furthermore, we've added an argument to the command line of kuard based on the EXTRA_PARAM value.

Next, click the "File system browser" tab (Figure 13-2). This lets you explore the file-system as the application sees it. You should see an entry called /config. This is a volume created based on our ConfigMap. If you navigate into that, you'll see that a file has been created for each entry of the ConfigMap. You'll also see some hidden files (prefixed with ..) that are used to do a clean swap of new values when the Config-Map is updated.

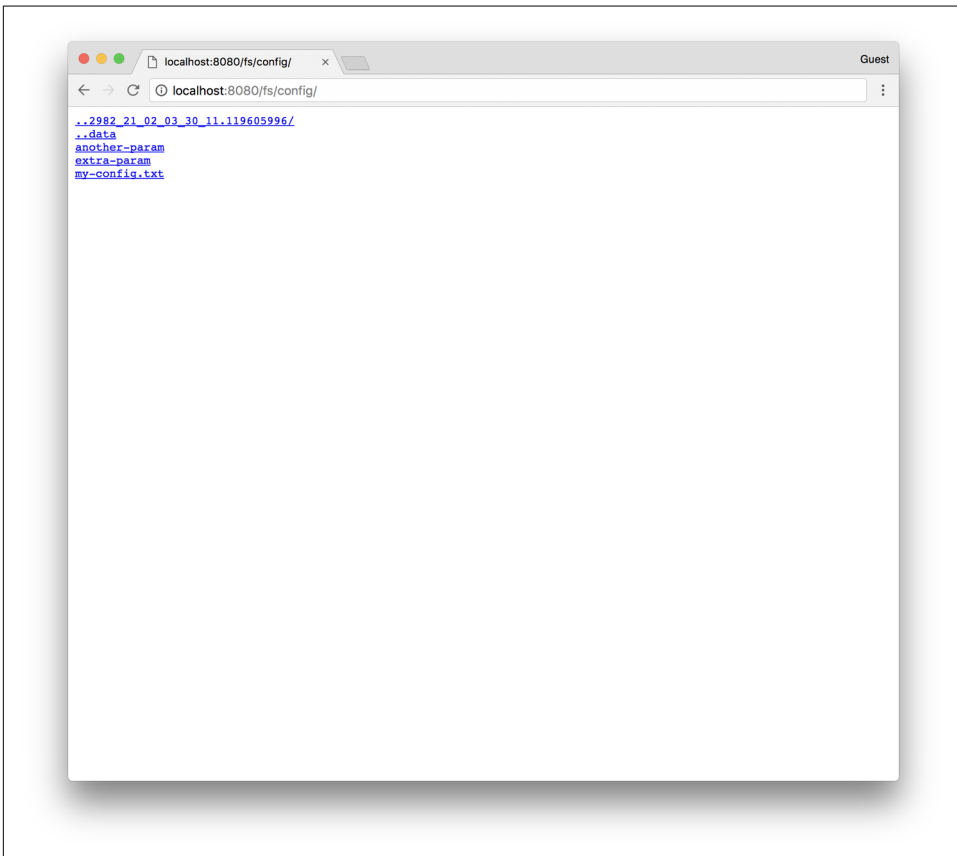

Figure 13-2. The /config directory as seen through kuard

Secrets

While ConfigMaps are great for most configuration data, there is certain data that is extra-sensitive. This can include passwords, security tokens, or other types of private

keys. Collectively, we call this type of data “secrets.” Kubernetes has native support for storing and handling this data with care.

Secrets enable container images to be created without bundling sensitive data. This allows containers to remain portable across environments. Secrets are exposed to Pods via explicit declaration in Pod manifests and the Kubernetes API. In this way, the Kubernetes secrets API provides an application-centric mechanism for exposing sensitive configuration information to applications in a way that’s easy to audit and leverages native OS isolation primitives.



By default, Kubernetes secrets are stored in plain text in the `etcd` storage for the cluster. Depending on your requirements, this may not be sufficient security for you. In particular, anyone who has cluster administration rights in your cluster will be able to read all of the secrets in the cluster. In recent versions of Kubernetes, support has been added for encrypting the secrets with a user-supplied key, generally integrated into a cloud key store. Additionally, most cloud key stores have integration with Kubernetes flexible volumes, enabling you to skip Kubernetes secrets entirely and rely exclusively on the cloud provider’s key store. All of these options should provide you with sufficient tools to craft a security profile that suits your needs.

The remainder of this section will explore how to create and manage Kubernetes secrets, and also lay out best practices for exposing secrets to Pods that require them.

Creating Secrets

Secrets are created using the Kubernetes API or the `kubectl` command-line tool. Secrets hold one or more data elements as a collection of key/value pairs.

In this section we will create a secret to store a TLS key and certificate for the `kuard` application that meets the storage requirements listed previously.



The `kuard` container image does not bundle a TLS certificate or key. This allows the `kuard` container to remain portable across environments and distributable through public Docker repositories.

The first step in creating a secret is to obtain the raw data we want to store. The TLS key and certificate for the `kuard` application can be downloaded by running the following commands:

```
$ curl -o kuard.crt https://storage.googleapis.com/kuar-demo/kuard.crt
$ curl -o kuard.key https://storage.googleapis.com/kuar-demo/kuard.key
```



These certificates are shared with the world and they provide no actual security. Please do not use them except as a learning tool in these examples.

With the *kuard.crt* and *kuard.key* files stored locally, we are ready to create a secret. Create a secret named *kuard-tls* using the `create secret` command:

```
$ kubectl create secret generic kuard-tls \
  --from-file=kuard.crt \
  --from-file=kuard.key
```

The *kuard-tls* secret has been created with two data elements. Run the following command to get details:

```
$ kubectl describe secrets kuard-tls
```

```
Name:          kuard-tls
Namespace:     default
Labels:        <none>
Annotations:   <none>

Type:          Opaque

Data
====
kuard.crt:    1050 bytes
kuard.key:    1679 bytes
```

With the *kuard-tls* secret in place, we can consume it from a Pod by using a secrets volume.

Consuming Secrets

Secrets can be consumed using the Kubernetes REST API by applications that know how to call that API directly. However, our goal is to keep applications portable. Not only should they run well in Kubernetes, but they should run, unmodified, on other platforms.

Instead of accessing secrets through the API server, we can use a *secrets volume*.

Secrets volumes

Secret data can be exposed to Pods using the secrets volume type. Secrets volumes are managed by the kubelet and are created at Pod creation time. Secrets are stored on tmpfs volumes (aka RAM disks), and as such are not written to disk on nodes.

Each data element of a secret is stored in a separate file under the target mount point specified in the volume mount. The *kuard-tls* secret contains two data elements:

kuard.crt and *kuard.key*. Mounting the `kuard-tls` secrets volume to `/tls` results in the following files:

```
/tls/kuard.crt
/tls/kuard.key
```

The Pod manifest in [Example 13-3](#) demonstrates how to declare a secrets volume, which exposes the `kuard-tls` secret to the `kuard` container under `/tls`.

Example 13-3. *kuard-secret.yaml*

```
apiVersion: v1
kind: Pod
metadata:
  name: kuard-tls
spec:
  containers:
    - name: kuard-tls
      image: gcr.io/kuar-demo/kuard-amd64:blue
      imagePullPolicy: Always
      volumeMounts:
        - name: tls-certs
          mountPath: "/tls"
          readOnly: true
  volumes:
    - name: tls-certs
      secret:
        secretName: kuard-tls
```

Create the `kuard-tls` Pod using `kubectl` and observe the log output from the running Pod:

```
$ kubectl apply -f kuard-secret.yaml
```

Connect to the Pod by running:

```
$ kubectl port-forward kuard-tls 8443:8443
```

Now navigate your browser to <https://localhost:8443>. You should see some invalid certificate warnings as this is a self-signed certificate for *kuard.example.com*. If you navigate past this warning, you should see the `kuard` server hosted via HTTPS. Use the “File system browser” tab to find the certificates on disk.

Private Docker Registries

A special use case for secrets is to store access credentials for private Docker registries. Kubernetes supports using images stored on private registries, but access to those images requires credentials. Private images can be stored across one or more private registries. This presents a challenge for managing credentials for each private registry on every possible node in the cluster.

Image pull secrets leverage the secrets API to automate the distribution of private registry credentials. Image pull secrets are stored just like normal secrets but are consumed through the `spec.imagePullSecrets` Pod specification field.

Use the `create secret docker-registry` to create this special kind of secret:

```
$ kubectl create secret docker-registry my-image-pull-secret \
  --docker-username=<username> \
  --docker-password=<password> \
  --docker-email=<email-address>
```

Enable access to the private repository by referencing the image pull secret in the Pod manifest file, as shown in [Example 13-4](#).

Example 13-4. kuard-secret-ips.yaml

```
apiVersion: v1
kind: Pod
metadata:
  name: kuard-tls
spec:
  containers:
    - name: kuard-tls
      image: gcr.io/kuar-demo/kuard-amd64:blue
      imagePullPolicy: Always
      volumeMounts:
        - name: tls-certs
          mountPath: "/tls"
          readOnly: true
  imagePullSecrets:
    - name: my-image-pull-secret
  volumes:
    - name: tls-certs
      secret:
        secretName: kuard-tls
```

If you are repeatedly pulling from the same registry, you can add the secrets to the default service account associated with each Pod to avoid having to specify the secrets in every Pod you create.

Naming Constraints

The key names for data items inside of a secret or ConfigMap are defined to map to valid environment variable names. They may begin with a dot followed by a letter or number. Following characters include dots, dashes, and underscores. Dots cannot be repeated and dots and underscores or dashes cannot be adjacent to each other. More formally, this means that they must conform to the regular expression

`^[.][?][a-zA-Z0-9]([.][?][a-zA-Z0-9][+][_a-zA-Z0-9[?)]*$`. Some examples of valid and invalid names for ConfigMaps and secrets are given in [Table 13-1](#).

Table 13-1. ConfigMap and secret key examples

Valid key name	Invalid key name
.auth_token	Token..properties
Key.pem	auth file.json
config_file	_password.txt



When selecting a key name, consider that these keys can be exposed to Pods via a volume mount. Pick a name that is going to make sense when specified on a command line or in a config file. Storing a TLS key as `key.pem` is more clear than `tls-key` when configuring applications to access secrets.

ConfigMap data values are simple UTF-8 text specified directly in the manifest. As of Kubernetes 1.6, ConfigMaps are unable to store binary data.

Secret data values hold arbitrary data encoded using base64. The use of base64 encoding makes it possible to store binary data. This does, however, make it more difficult to manage secrets that are stored in YAML files as the base64-encoded value must be put in the YAML. Note that the maximum size for a ConfigMap or secret is 1 MB.

Managing ConfigMaps and Secrets

Secrets and ConfigMaps are managed through the Kubernetes API. The usual `create`, `delete`, `get`, and `describe` commands work for manipulating these objects.

Listing

You can use the `kubectl get secrets` command to list all secrets in the current namespace:

```
$ kubectl get secrets
```

NAME	TYPE	DATA	AGE
default-token-f5jq2	kubernetes.io/service-account-token	3	1h
kuard-tls	Opaque	2	20m

Similarly, you can list all of the ConfigMaps in a namespace:

```
$ kubectl get configmaps
```

NAME	DATA	AGE
my-config	3	1m

kubectl describe can be used to get more details on a single object:

```
$ kubectl describe configmap my-config
```

```
Name:          my-config
Namespace:     default
Labels:        <none>
Annotations:   <none>
```

```
Data
====
another-param: 13 bytes
extra-param:   11 bytes
my-config.txt: 116 bytes
```

Finally, you can see the raw data (including values in secrets!) with something like `kubectl get configmap my-config -o yaml` or `kubectl get secret kuard-tls -o yaml`.

Creating

The easiest way to create a secret or a ConfigMap is via `kubectl create secret generic` or `kubectl create configmap`. There are a variety of ways to specify the data items that go into the secret or ConfigMap. These can be combined in a single command:

```
--from-file=<filename>
```

Load from the file with the secret data key the same as the filename.

```
--from-file=<key>=<filename>
```

Load from the file with the secret data key explicitly specified.

```
--from-file=<directory>
```

Load all the files in the specified directory where the filename is an acceptable key name.

```
--from-literal=<key>=<value>
```

Use the specified key/value pair directly.

Updating

You can update a ConfigMap or secret and have it reflected in running programs. There is no need to restart if the application is configured to reread configuration values. This is a rare feature but might be something you put in your own applications.

The following are three ways to update ConfigMaps or secrets.

Update from file

If you have a manifest for your ConfigMap or secret, you can just edit it directly and push a new version with `kubectl replace -f <filename>`. You can also use `kubectl apply -f <filename>` if you previously created the resource with `kubectl apply`.

Due to the way that datafiles are encoded into these objects, updating a configuration can be a bit cumbersome as there is no provision in `kubectl` to load data from an external file. The data must be stored directly in the YAML manifest.

The most common use case is when the ConfigMap is defined as part of a directory or list of resources and everything is created and updated together. Oftentimes these manifests will be checked into source control.



It is generally a bad idea to check secret YAML files into source control. It is too easy to push these files someplace public and leak your secrets.

Recreate and update

If you store the inputs into your ConfigMaps or secrets as separate files on disk (as opposed to embedded into YAML directly), you can use `kubectl` to recreate the manifest and then use it to update the object.

This will look something like this:

```
$ kubectl create secret generic kuard-tls \  
  --from-file=kuard.crt --from-file=kuard.key \  
  --dry-run -o yaml | kubectl replace -f -
```

This command line first creates a new secret with the same name as our existing secret. If we just stopped there, the Kubernetes API server would return an error complaining that we are trying to create a secret that already exists. Instead, we tell `kubectl` not to actually send the data to the server but instead to dump the YAML that it *would have* sent to the API server to `stdout`. We then pipe that to `kubectl replace` and use `-f -` to tell it to read from `stdin`. In this way, we can update a secret from files on disk without having to manually base64-encode data.

Edit current version

The final way to update a ConfigMap is to use `kubectl edit` to bring up a version of the ConfigMap in your editor so you can tweak it (you could also do this with a secret, but you'd be stuck managing the base64 encoding of values on your own):

```
$ kubectl edit configmap my-config
```

You should see the ConfigMap definition in your editor. Make your desired changes and then save and close your editor. The new version of the object will be pushed to the Kubernetes API server.

Live updates

Once a ConfigMap or secret is updated using the API, it'll be automatically pushed to all volumes that use that ConfigMap or secret. It may take a few seconds, but the file listing and contents of the files, as seen by kuard, will be updated with these new values. Using this live update feature you can update the configuration of applications without restarting them.

Currently there is no built-in way to signal an application when a new version of a ConfigMap is deployed. It is up to the application (or some helper script) to look for the config files to change and reload them.

Using the file browser in kuard (accessed through `kubectl port-forward`) is a great way to interactively play with dynamically updating secrets and ConfigMaps.

Summary

ConfigMaps and secrets are a great way to provide dynamic configuration in your application. They allow you to create a container image (and Pod definition) once and reuse it in different contexts. This can include using the exact same image as you move from dev to staging to production. It can also include using a single image across multiple teams and services. Separating configuration from application code will make your applications more reliable and reusable.

Role-Based Access Control for Kubernetes

At this point, nearly every Kubernetes cluster you encounter has role-based access control (RBAC) enabled. So you likely have at least partially encountered RBAC before. Perhaps you initially couldn't access your cluster until you used some magical incantation to add a RoleBinding to map a user to a role. However, even though you may have had some exposure to RBAC, you may not have had a great deal of experience understanding RBAC in Kubernetes, what it is for, and how to use it successfully. That is the subject of this chapter.

RBAC was introduced into Kubernetes with version 1.5 and became generally available in Kubernetes 1.8. Role-based access control provides a mechanism for restricting both access to and actions on Kubernetes APIs to ensure that only appropriate users have access to APIs in the cluster. RBAC is a critical component to both harden access to the Kubernetes cluster where you are deploying your application and (possibly more importantly) prevent unexpected accidents where one person in the wrong namespace mistakenly takes down production when they think they are destroying their test cluster.



Multitenant security in Kubernetes is a complex, multifaceted topic worthy of its own volume. While RBAC can be quite useful in limiting access to the Kubernetes API, it's important to remember that anyone who can run arbitrary code inside the Kubernetes cluster can effectively obtain root privileges on the entire cluster. There are approaches that you can take to make such attacks harder and more expensive, and a correct RBAC setup is part of this defense. But if you are focused on hostile multitenant security, do not believe that RBAC by itself is sufficient to protect you. You must isolate the Pods running in your cluster to provide effective multitenant security. Generally this is done with a hypervisor isolated container, or some sort of container sandbox, or both.

Before we dive into the details of RBAC in Kubernetes, it's valuable to have a high-level understanding of RBAC as a concept, as well as authentication and authorization more generally.

Every request to Kubernetes is first *authenticated*. Authentication provides the identity of the caller issuing the request. It could be as simple as saying that the request is unauthenticated, or it could integrate deeply with a pluggable authentication provider (e.g., Azure Active Directory) to establish an identity within that third-party system. Interestingly enough, Kubernetes does not have a built-in identity store, focusing instead on integrating other identity sources within itself.

Once users have been properly identified, the authorization phase determines whether they are authorized to perform the request. Authorization is a combination of the identity of the user, the resource (effectively the HTTP path), and the verb or action the user is attempting to perform. If the particular user is authorized for performing that action on that resource, then the request is allowed to proceed. Otherwise, an HTTP 403 error is returned. More details of this process are given in the following sections.

Role-Based Access Control

To properly manage access in Kubernetes, it's critical to understand how identity, roles, and role bindings interact to control who can do what with what resources. At first, RBAC can seem like a challenge to understand, with a series of interconnected, abstract concepts; but once understood, managing cluster access is straightforward and safe.

Identity in Kubernetes

Every request that comes to Kubernetes is associated with some identity. Even a request with no identity is associated with the `system:unauthenticated` group. Kubernetes makes a distinction between user identities and service account identities. Service accounts are created and managed by Kubernetes itself and are generally associated with components running inside the cluster. User accounts are all other accounts associated with actual users of the cluster, and often include automation like continuous delivery as a service that runs outside of the cluster.

Kubernetes uses a generic interface for authentication providers. Each of the providers supplies a username and optionally the set of groups to which the user belongs.

Kubernetes supports a number of different authentication providers, including:

- HTTP Basic Authentication (largely deprecated)
- x509 client certificates

- Static token files on the host
- Cloud authentication providers like Azure Active Directory and AWS Identity and Access Management (IAM)
- Authentication webhooks

While most managed Kubernetes installations configure authentication for you, if you are deploying your own authentication you will need to configure flags on the Kubernetes API server appropriately.

Understanding Roles and Role Bindings

Identity is just the beginning of authorization in Kubernetes. Once the system knows the identity of the request, it needs to determine if the request is authorized for that user. To achieve this, it uses the general concept of roles and role bindings.

A *role* is a set of abstract capabilities. For example, the `appdev` role might represent the ability to create Pods and services. A *role binding* is an assignment of a role to one or more identities. Thus, binding the `appdev` role to the user identity `alice` indicates that Alice has the ability to create Pods and services.

Roles and Role Bindings in Kubernetes

In Kubernetes there are two pairs of related resources that represent roles and role bindings. One pair applies to just a namespace (`Role` and `RoleBinding`) while the other pair applies across the cluster (`ClusterRole` and `ClusterRoleBinding`).

Let's examine `Role` and `RoleBinding` first. `Role` resources are namespaced, and represent capabilities within that single namespace. You cannot use namespaced roles for non-namespaced resources (e.g., `CustomResourceDefinitions`), and binding a `RoleBinding` to a role only provides authorization within the Kubernetes namespace that contains both the `Role` and the `RoleDefinition`.

As a concrete example, here is a simple role that gives an identity the ability to create and modify Pods and services:

```
kind: Role
apiVersion: rbac.authorization.k8s.io/v1
metadata:
  namespace: default
  name: pod-and-services
rules:
- apiGroups: [""]
  resources: ["pods", "services"]
  verbs: ["create", "delete", "get", "list", "patch", "update", "watch"]
```

To bind this Role to the user `alice`, we need to create a `RoleBinding` that looks as follows. This role binding also binds the group `mydevs` to the same role:

```
apiVersion: rbac.authorization.k8s.io/v1
kind: RoleBinding
metadata:
  namespace: default
  name: pods-and-services
subjects:
- apiGroup: rbac.authorization.k8s.io
  kind: User
  name: alice
- apiGroup: rbac.authorization.k8s.io
  kind: Group
  name: mydevs
roleRef:
  apiGroup: rbac.authorization.k8s.io
  kind: Role
  name: pod-and-services
```

Of course, sometimes you want to create a role that applies to the entire cluster, or you want to limit access to cluster-level resources. To achieve this, you use the `ClusterRole` and `ClusterRoleBinding` resources. They are largely identical to their namespaced peers, but with larger scope.

Verbs for Kubernetes roles

Roles are defined in terms of both a resource (e.g., “Pods”) and a verb that describes an action that can be performed on that resource. The verbs correspond roughly to HTTP methods. The commonly used verbs in Kubernetes RBAC are listed in [Table 14-1](#).

Table 14-1. Common Kubernetes RBAC verbs

Verb	HTTP method	Description
<code>create</code>	POST	Create a new resource.
<code>delete</code>	DELETE	Delete an existing resource.
<code>get</code>	GET	Get a resource.
<code>list</code>	GET	List a collection of resources.
<code>patch</code>	PATCH	Modify an existing resource via a partial change.
<code>update</code>	PUT	Modify an existing resource via a complete object.
<code>watch</code>	GET	Watch for streaming updates to a resource.
<code>proxy</code>	GET	Connect to resource via a streaming WebSocket proxy.

Using built-in roles

Of course, designing your own roles can be complicated and time-consuming. Furthermore, Kubernetes has a large number of well-known system identities (e.g., a scheduler) that require a known set of capabilities. Consequently, Kubernetes has a large number of built-in cluster roles. You can view these by running:

```
$ kubectl get clusterroles
```

While most of these built-in roles are for system utilities, four are designed for generic end users:

- The `cluster-admin` role provides complete access to the entire cluster.
- The `admin` role provides complete access to a complete namespace.
- The `edit` role allows an end user to modify things in a namespace.
- The `view` role allows for read-only access to a namespace.

Most clusters already have numerous `ClusterRole` bindings set up, and you can view these bindings with `kubectl get clusterrolebindings`.

Auto-reconciliation of built-in roles

When the Kubernetes API server starts up, it automatically installs a number of default `ClusterRoles` that are defined in the code of the API server itself. This means that if you modify any built-in cluster role, those modifications are transient. Whenever the API server is restarted (e.g., for an upgrade) your changes will be overwritten.

To prevent this from happening, before you make any other modifications you need to add the `rbac.authorization.kubernetes.io/autoupdate` annotation with a value of `false` to the built-in `ClusterRole` resource. If this annotation is set to `false`, the API server will not overwrite the modified `ClusterRole` resource.



By default, the Kubernetes API server installs a cluster role that allows `system:unauthenticated` users access to the API server's API discovery endpoint. For any cluster exposed to a hostile environment (e.g., the public internet) this is a bad idea, and there has been at least one serious security vulnerability via this exposure. Consequently, if you are running a Kubernetes service on the public internet or an other hostile environment, you should ensure that the `--anonymous-auth=false` flag is set on your API server.

Techniques for Managing RBAC

Managing RBAC for a cluster can be complicated and frustrating. Possibly more concerning is that misconfigured RBAC can lead to security issues. Fortunately, there are several tools and techniques that make managing RBAC easier.

Testing Authorization with `can-i`

The first useful tool is the `auth can-i` command for `kubectl`. This tool is very useful for testing if a particular user can do a particular action. You can use `can-i` to validate configuration settings as you configure your cluster, or you can ask users to use the tool to validate their access when filing errors or bug reports.

In its simplest usage, the `can-i` command takes a verb and a resource.

For example, this command will indicate if the current `kubectl` user is authorized to create Pods:

```
$ kubectl auth can-i create pods
```

You can also test subresources like logs or port forwarding with the `--subresource` command-line flag:

```
$ kubectl auth can-i get pods --subresource=logs
```

Managing RBAC in Source Control

Like all resources in Kubernetes, RBAC resources are modeled using JSON or YAML. Given this text-based representation it makes sense to store these resources in version control. Indeed, the strong need for audit, accountability, and rollback for changes to RBAC policy means that version control for RBAC resources is essential.

Fortunately, the `kubectl` command-line tool comes with a `reconcile` command that operates somewhat like `kubectl apply` and will reconcile a text-based set of roles and role bindings with the current state of the cluster.

You can run:

```
$ kubectl auth reconcile -f some-rbac-config.yaml
```

and the data in the file will be reconciled with the cluster. If you want to see changes before they are made, you can add the `--dry-run` flag to the command to print but not submit the changes.

Advanced Topics

Once you orient to the basics of role-based access control it is relatively easy to manage access to a Kubernetes cluster, but when managing a large number of users or

roles, there are additional advanced capabilities you can use to manage RBAC at scale.

Aggregating ClusterRoles

Sometimes you want to be able to define roles that are combinations of other roles. One option would be to simply clone all of the rules from one `ClusterRole` into another `ClusterRole`, but this is complicated and error-prone, since changes to one `ClusterRole` aren't automatically reflected in the other. Instead, Kubernetes RBAC supports the usage of an *aggregation rule* to combine multiple roles together in a new role. This new role combines all of the capabilities of all of the aggregate roles together, and any changes to any of the constituent subroles will automatically be propagated back into the aggregate role.

Like with all other aggregations or groupings in Kubernetes, the `ClusterRoles` to be aggregated are specified using label selectors. In this particular case, the `aggregationRule` field in the `ClusterRole` resource contains a `clusterRoleSelector` field, which in turn is a label selector. All `ClusterRole` resources that match this selector are dynamically aggregated into the `rules` array in the aggregate `ClusterRole` resource.

A best practice for managing `ClusterRole` resources is to create a number of fine-grained cluster roles and then aggregate them together to form higher-level or broadly defined cluster roles. This is how the built-in cluster roles are defined. For example, you can see that the built-in `edit` role looks like this:

```
apiVersion: rbac.authorization.k8s.io/v1
kind: ClusterRole
metadata:
  name: edit
  ...
aggregationRule:
  clusterRoleSelectors:
  - matchLabels:
      rbac.authorization.k8s.io/aggregate-to-edit: "true"
  ...
```

This means that the `edit` role is defined to be the aggregate of all `ClusterRole` objects that have a label of `rbac.authorization.k8s.io/aggregate-to-edit` set to `true`.

Using Groups for Bindings

When managing a large number of people in different organizations with similar access to the cluster, it's generally a best practice to use groups to manage the roles that define access to the cluster, rather than individually adding bindings to specific identities. When you bind a group to a `ClusterRole` or a `namespace Role`, anyone

who is a member of that group gains access to the resources and verbs defined by that role. Thus, to enable any individual to gain access to the group's role, that individual needs to be added to the group.

There are several reasons why using groups is a preferred strategy for managing access at scale. The first is that in any large organization, access to the cluster is defined in terms of the team that someone is part of, rather than their specific identity. For example, someone who is part of the frontend operations team will need access to both view and edit the resources associated with the frontends, while they may only need view/read access to resources associated with the backend. Granting privileges to a group makes the association between the specific team and its capabilities clear. When granting roles to individuals, it's much harder to clearly understand the appropriate (i.e., minimal) privileges required for each team, especially when an individual may be part of multiple different teams.

Additional benefits of binding roles to groups instead of individuals are simplicity and consistency. When someone joins or leaves a team, it is straightforward to simply add or remove them to or from a group in a single operation. If you instead have to remove a number of different role bindings for their identity, you may either remove too few or too many bindings, resulting in unnecessary access or preventing them from being able to do necessary actions. Additionally, because there is only a single set of group role bindings to maintain, you don't have to do lots of work to ensure that all team members have the same, consistent set of permissions.

Furthermore, many group systems enable “just in time” (JIT) access such that people are only temporarily added to a group in response to an event (say, a page in the middle of the night) rather than having standing access. This means that you can both audit who had access at any particular time and ensure that, in general, even a compromised identity can't have access to your production infrastructure.

Finally, in many cases these same groups are used to manage access to other resources, from facilities to documents and machine logins. Thus, using the same groups for access control to Kubernetes dramatically simplifies management.

To bind a group to a `ClusterRole` you use a `Group` kind for the subject in the binding:

```
...
subjects:
- apiGroup: rbac.authorization.k8s.io
  kind: Group
  name: my-great-groups-name
...
```

In Kubernetes, groups are supplied by authentication providers. There is no strong notion of a group within Kubernetes, only that an identity can be part of one or more groups, and those groups can be associated with a `Role` or `ClusterRole` via a binding.

Summary

When you begin with a small cluster and a small team, it is sufficient to have every member of the team have equivalent access to the cluster. But as teams grow and products become more mission critical, limiting access to parts of the cluster is crucial. In a well-designed cluster, access is limited to the minimal set of people and capabilities needed to efficiently manage the applications in the cluster. Understanding how Kubernetes implements RBAC and how those capabilities can be used to control access to your cluster is important for both developers and cluster administrators. As with building out testing infrastructure, best practice is to set up proper RBAC earlier rather than later. It's far easier to start with the right foundation than to try to retrofit it later on. Hopefully, the information in this chapter has provided the necessary grounding for adding RBAC to your cluster.

Integrating Storage Solutions and Kubernetes

In many cases, decoupling state from applications and building your microservices to be as stateless as possible results in maximally reliable, manageable systems.

However, nearly every system that has any complexity has state in the system somewhere, from the records in a database to the index shards that serve results for a web search engine. At some point, you have to have data stored somewhere.

Integrating this data with containers and container orchestration solutions is often the most complicated aspect of building a distributed system. This complexity largely stems from the fact that the move to containerized architectures is also a move toward decoupled, immutable, and declarative application development. These patterns are relatively easy to apply to stateless web applications, but even “cloud-native” storage solutions like Cassandra or MongoDB involve some sort of manual or imperative steps to set up a reliable, replicated solution.

As an example of this, consider setting up a ReplicaSet in MongoDB, which involves deploying the Mongo daemon and then running an imperative command to identify the leader, as well as the participants in the Mongo cluster. Of course, these steps can be scripted, but in a containerized world it is difficult to see how to integrate such commands into a deployment. Likewise, even getting DNS-resolvable names for individual containers in a replicated set of containers is challenging.

Additional complexity comes from the fact that there is data gravity. Most containerized systems aren’t built in a vacuum; they are usually adapted from existing systems deployed onto VMs, and these systems likely include data that has to be imported or migrated.

Finally, evolution to the cloud often means that storage is an externalized cloud service, and in that context it can never really exist inside of the Kubernetes cluster.

This chapter covers a variety of approaches for integrating storage into containerized microservices in Kubernetes. First, we cover how to import existing external storage solutions (either cloud services or running on VMs) into Kubernetes. Next, we explore how to run reliable singletons inside of Kubernetes that enable you to have an environment that largely matches the VMs where you previously deployed storage solutions. Finally, we cover StatefulSets, which are still under development but represent the future of stateful workloads in Kubernetes.

Importing External Services

In many cases, you have an existing machine running in your network that has some sort of database running on it. In this situation you may not want to immediately move that database into containers and Kubernetes. Perhaps it is run by a different team, or you are doing a gradual move, or the task of migrating the data is simply more trouble than it's worth.

Regardless of the reasons for staying put, this legacy server and service are not going to move into Kubernetes—but it's still worthwhile to represent this server in Kubernetes. When you do this, you get to take advantage of all of the built-in naming and service-discovery primitives provided by Kubernetes. Additionally, this enables you to configure all your applications so that it looks like the database that is running on a machine somewhere is actually a Kubernetes service. This means that it is trivial to replace it with a database that is a Kubernetes service. For example, in production, you may rely on your legacy database that is running on a machine, but for continuous testing you may deploy a test database as a transient container. Since it is created and destroyed for each test run, data persistence isn't important in the continuous testing case. Representing both databases as Kubernetes services enables you to maintain identical configurations in both testing and production. High fidelity between test and production ensures that passing tests will lead to successful deployment in production.

To see concretely how you maintain high fidelity between development and production, remember that all Kubernetes objects are deployed into *namespaces*. Imagine that we have test and production namespaces defined. The test service is imported using an object like:

```
kind: Service
metadata:
  name: my-database
  # note 'test' namespace here
  namespace: test
...
```

The production service looks the same, except it uses a different namespace:

```
kind: Service
metadata:
  name: my-database
  # note 'prod' namespace here
  namespace: prod
...
```

When you deploy a Pod into the `test` namespace and it looks up the service named `my-database`, it will receive a pointer to `my-database.test.svc.cluster.internal`, which in turn points to the test database. In contrast, when a Pod deployed in the `prod` namespace looks up the same name (`my-database`) it will receive a pointer to `my-database.prod.svc.cluster.internal`, which is the production database. Thus, the same service name, in two different namespaces, resolves to two different services. For more details on how this works, see [Chapter 7](#).



The following techniques all use database or other storage services, but these approaches can be used equally well with other services that aren't running inside your Kubernetes cluster.

Services Without Selectors

When we first introduced services, we talked at length about label queries and how they were used to identify the dynamic set of Pods that were the backends for a particular service. With external services, however, there is no such label query. Instead, you generally have a DNS name that points to the specific server running the database. For our example, let's assume that this server is named `database.company.com`. To import this external database service into Kubernetes, we start by creating a service without a Pod selector that references the DNS name of the database server ([Example 15-1](#)).

Example 15-1. dns-service.yaml

```
kind: Service
apiVersion: v1
metadata:
  name: external-database
spec:
  type: ExternalName
  externalName: database.company.com
```

When a typical Kubernetes service is created, an IP address is also created and the Kubernetes DNS service is populated with an A record that points to that IP address. When you create a service of type `ExternalName`, the Kubernetes DNS service is

instead populated with a CNAME record that points to the external name you specified (`database.company.com` in this case). When an application in the cluster does a DNS lookup for the hostname `external-database.svc.default.cluster`, the DNS protocol aliases that name to `database.company.com`. This then resolves to the IP address of your external database server. In this way, all containers in Kubernetes believe that they are talking to a service that is backed with other containers, when in fact they are being redirected to the external database.

Note that this is not restricted to databases you are running on your own infrastructure. Many cloud databases and other services provide you with a DNS name to use when accessing the database (e.g., `my-database.databases.cloudprovider.com`). You can use this DNS name as the `externalName`. This imports the cloud-provided database into the namespace of your Kubernetes cluster.

Sometimes, however, you don't have a DNS address for an external database service, just an IP address. In such cases, it is still possible to import this service as a Kubernetes service, but the operation is a little different. First, you create a Service without a label selector, but also without the `ExternalName` type we used before ([Example 15-2](#)).

Example 15-2. external-ip-service.yaml

```
kind: Service
apiVersion: v1
metadata:
  name: external-ip-database
```

At this point, Kubernetes will allocate a virtual IP address for this service and populate an A record for it. However, because there is no selector for the service, there will be no endpoints populated for the load balancer to redirect traffic to.

Given that this is an external service, the user is responsible for populating the endpoints manually with an Endpoints resource ([Example 15-3](#)).

Example 15-3. external-ip-endpoints.yaml

```
kind: Endpoints
apiVersion: v1
metadata:
  name: external-ip-database
subsets:
  - addresses:
    - ip: 192.168.0.1
    ports:
    - port: 3306
```

If you have more than one IP address for redundancy, you can repeat them in the `addresses` array. Once the endpoints are populated, the load balancer will start redirecting traffic from your Kubernetes service to the IP address endpoint(s).



Because the user has assumed responsibility for keeping the IP address of the server up to date, you need to either ensure that it never changes or make sure that some automated process updates the `Endpoints` record.

Limitations of External Services: Health Checking

External services in Kubernetes have one significant restriction: they do not perform any health checking. The user is responsible for ensuring that the endpoint or DNS name supplied to Kubernetes is as reliable as necessary for the application.

Running Reliable Singletons

The challenge of running storage solutions in Kubernetes is often that primitives like `ReplicaSet` expect that every container is identical and replaceable, but for most storage solutions this isn't the case. One option to address this is to use Kubernetes primitives, but not attempt to replicate the storage. Instead, simply run a single Pod that runs the database or other storage solution. In this way the challenges of running replicated storage in Kubernetes don't occur, since there is no replication.

At first blush, this might seem to run counter to the principles of building reliable distributed systems, but in general, it is no less reliable than running your database or storage infrastructure on a single virtual or physical machine, which is how many people currently have built their systems. Indeed, in reality, if you structure the system properly the only thing you are sacrificing is potential downtime for upgrades or in case of machine failure. While for large-scale or mission-critical systems this may not be acceptable, for many smaller-scale applications this kind of limited downtime is a reasonable trade-off for the reduced complexity. If this is not true for you, feel free to skip this section and either import existing services as described in the previous section, or move on to Kubernetes-native `StatefulSets`, described in the following section. For everyone else, we'll review how to build reliable singletons for data storage.

Running a MySQL Singleton

In this section, we'll describe how to run a reliable singleton instance of the MySQL database as a Pod in Kubernetes, and how to expose that singleton to other applications in the cluster.

To do this, we are going to create three basic objects:

- A persistent volume to manage the lifespan of the on-disk storage independently from the lifespan of the running MySQL application
- A MySQL Pod that will run the MySQL application
- A service that will expose this Pod to other containers in the cluster

In [Chapter 5](#) we described persistent volumes, but a quick review makes sense. A persistent volume is a storage location that has a lifetime independent of any Pod or container. This is very useful in the case of persistent storage solutions where the on-disk representation of a database should survive even if the containers running the database application crash, or move to different machines. If the application moves to a different machine, the volume should move with it, and data should be preserved. Separating the data storage out as a persistent volume makes this possible.

To begin, we'll create a persistent volume for our MySQL database to use. This example uses NFS for maximum portability, but Kubernetes supports many different persistent volume drive types. For example, there are persistent volume drivers for all major public cloud providers, as well as many private cloud providers. To use these solutions, simply replace `nfs` with the appropriate cloud provider volume type (e.g., `azure`, `awsElasticBlockStore`, or `gcePersistentDisk`). In all cases, this change is all you need. Kubernetes knows how to create the appropriate storage disk in the respective cloud provider. This is a great example of how Kubernetes simplifies the development of reliable distributed systems.

[Example 15-4](#) shows the `PersistentVolume` object.

Example 15-4. `nfs-volume.yaml`

```
apiVersion: v1
kind: PersistentVolume
metadata:
  name: database
  labels:
    volume: my-volume
spec:
  accessModes:
    - ReadWriteMany
  capacity:
    storage: 1Gi
  nfs:
    server: 192.168.0.1
    path: "/exports"
```

This defines an NFS `PersistentVolume` object with 1 GB of storage space.

We can create this persistent volume as usual with:

```
$ kubectl apply -f nfs-volume.yaml
```

Now that we have a persistent volume created, we need to claim that persistent volume for our Pod. We do this with a `PersistentVolumeClaim` object (Example 15-5).

Example 15-5. nfs-volume-claim.yaml

```
kind: PersistentVolumeClaim
apiVersion: v1
metadata:
  name: database
spec:
  accessModes:
  - ReadWriteMany
  resources:
    requests:
      storage: 1Gi
  selector:
    matchLabels:
      volume: my-volume
```

The `selector` field uses labels to find the matching volume we defined previously.

This kind of indirection may seem overly complicated, but it has a purpose—it serves to isolate our Pod definition from our storage definition. You can declare volumes directly inside a Pod specification, but this locks that Pod specification to a particular volume provider (e.g., a specific public or private cloud). By using volume claims, you can keep your Pod specifications cloud-agnostic; simply create different volumes, specific to the cloud, and use a `PersistentVolumeClaim` to bind them together. Furthermore, in many cases, the persistent volume controller will actually automatically create a volume for you—there are more details of this process in the following section.

Now that we've claimed our volume, we can use a `ReplicaSet` to construct our singleton Pod. It might seem odd that we are using a `ReplicaSet` to manage a single Pod, but it is necessary for reliability. Remember that once scheduled to a machine, a bare Pod is bound to that machine forever. If the machine fails, then any Pods that are on that machine that are not being managed by a higher-level controller like a `ReplicaSet` vanish along with the machine and are not rescheduled elsewhere. Consequently, to ensure that our database Pod is rescheduled in the presence of machine failures, we use the higher-level `ReplicaSet` controller, with a replica size of one, to manage our database (Example 15-6).

Example 15-6. mysql-replicaset.yaml

```
apiVersion: extensions/v1
kind: ReplicaSet
metadata:
  name: mysql
```

```

# labels so that we can bind a Service to this Pod
labels:
  app: mysql
spec:
  replicas: 1
  selector:
    matchLabels:
      app: mysql
  template:
    metadata:
      labels:
        app: mysql
    spec:
      containers:
        - name: database
          image: mysql
          resources:
            requests:
              cpu: 1
              memory: 2Gi
          env:
            # Environment variables are not a best practice for security,
            # but we're using them here for brevity in the example.
            # See Chapter 11 for better options.
            - name: MYSQL_ROOT_PASSWORD
              value: some-password-here
          livenessProbe:
            tcpSocket:
              port: 3306
          ports:
            - containerPort: 3306
          volumeMounts:
            - name: database
              # /var/lib/mysql is where MySQL stores its databases
              mountPath: "/var/lib/mysql"
      volumes:
        - name: database
          persistentVolumeClaim:
            claimName: database

```

Once we create the ReplicaSet it will, in turn, create a Pod running MySQL using the persistent disk we originally created. The final step is to expose this as a Kubernetes service ([Example 15-7](#)).

Example 15-7. mysql-service.yaml

```

apiVersion: v1
kind: Service
metadata:
  name: mysql
spec:

```

```
ports:
- port: 3306
  protocol: TCP
selector:
  app: mysql
```

Now we have a reliable singleton MySQL instance running in our cluster and exposed as a service named `mysql`, which we can access at the full domain name `mysql.svc.default.cluster`.

Similar instructions can be used for a variety of data stores, and if your needs are simple and you can survive limited downtime in the face of a machine failure or when you need to upgrade the database software, a reliable singleton may be the right approach to storage for your application.

Dynamic Volume Provisioning

Many clusters also include *dynamic volume provisioning*. With dynamic volume provisioning, the cluster operator creates one or more `StorageClass` objects. [Example 15-8](#) shows a default storage class that automatically provisions disk objects on the Microsoft Azure platform.

Example 15-8. storageclass.yaml

```
apiVersion: storage.k8s.io/v1
kind: StorageClass
metadata:
  name: default
  annotations:
    storageclass.beta.kubernetes.io/is-default-class: "true"
  labels:
    kubernetes.io/cluster-service: "true"
provisioner: kubernetes.io/azure-disk
```

Once a storage class has been created for a cluster, you can refer to this storage class in your persistent volume claim, rather than referring to any specific persistent volume. When the dynamic provisioner sees this storage claim, it uses the appropriate volume driver to create the volume and bind it to your persistent volume claim.

[Example 15-9](#) shows an example of a `PersistentVolumeClaim` that uses the default storage class we just defined to claim a newly created persistent volume.

Example 15-9. dynamic-volume-claim.yaml

```
kind: PersistentVolumeClaim
apiVersion: v1
metadata:
```

```
name: my-claim
annotations:
  volume.beta.kubernetes.io/storage-class: default
spec:
  accessModes:
  - ReadWriteOnce
  resources:
    requests:
      storage: 10Gi
```

The `volume.beta.kubernetes.io/storage-class` annotation is what links this claim back up to the storage class we created.



Automatic provisioning of a persistent volume is a great feature that makes it significantly easier to build and manage stateful applications in Kubernetes. However, the lifespan of these persistent volumes is dictated by the reclamation policy of the `PersistentVolumeClaim` and the default is to bind that lifespan to the lifespan of the Pod that creates the volume.

This means that if you happen to delete the Pod (e.g., via a scale-down or other event), then the volume is deleted as well. While this may be what you want in certain circumstances, you need to be careful to ensure that you don't accidentally delete your persistent volumes.

Persistent volumes are great for traditional applications that require storage, but if you need to develop high-availability, scalable storage in a Kubernetes-native fashion, the newly released `StatefulSet` object can be used instead. We'll describe how to deploy MongoDB using `StatefulSets` in the next section.

Kubernetes-Native Storage with `StatefulSets`

When Kubernetes was first developed, there was a heavy emphasis on homogeneity for all replicas in a replicated set. In this design, no replica had an individual identity or configuration. It was up to the application developer to determine a design that could establish this identity for their application.

While this approach provides a great deal of isolation for the orchestration system, it also makes it quite difficult to develop stateful applications. After significant input from the community and a great deal of experimentation with various existing stateful applications, `StatefulSets` were introduced in Kubernetes version 1.5.

Properties of StatefulSets

StatefulSets are replicated groups of Pods, similar to ReplicaSets. But unlike a ReplicaSet, they have certain unique properties:

- Each replica gets a persistent hostname with a unique index (e.g., database-0, database-1, etc.).
- Each replica is created in order from lowest to highest index, and creation will block until the Pod at the previous index is healthy and available. This also applies to scaling up.
- When a StatefulSet is deleted, each of the managed replica Pods is also deleted in order from highest to lowest. This also applies to scaling down the number of replicas.

It turns out that this simple set of requirements makes it drastically easier to deploy storage applications on Kubernetes. For example, the combination of stable hostnames (e.g., database-0) and the ordering constraints mean that all replicas, other than the first one, can reliably reference database-0 for the purposes of discovery and establishing replication quorum.

Manually Replicated MongoDB with StatefulSets

In this section, we'll deploy a replicated MongoDB cluster. For now, the replication setup itself will be done manually to give you a feel for how StatefulSets work. Eventually we will automate this setup as well.

To start, we'll create a replicated set of three MongoDB Pods using a StatefulSet object ([Example 15-10](#)).

Example 15-10. mongo-simple.yaml

```
apiVersion: apps/v1
kind: StatefulSet
metadata:
  name: mongo
spec:
  serviceName: "mongo"
  replicas: 3
  template:
    metadata:
      labels:
        app: mongo
    spec:
      containers:
        - name: mongod
          image: mongo:3.4.1
```



```
command:
- mongod
- --replSet
- rs0
ports:
- containerPort: 27017
name: peer
```

As you can see, the definition is similar to the ReplicaSet definitions we've seen previously. The only changes are in the `apiVersion` and `kind` fields.

Create the StatefulSet:

```
$ kubectl apply -f mongo-simple.yaml
```

Once created, the differences between a ReplicaSet and a StatefulSet become apparent. Run `kubectl get pods` and you will likely see:

NAME	READY	STATUS	RESTARTS	AGE
mongo-0	1/1	Running	0	1m
mongo-1	0/1	ContainerCreating	0	10s

There are two important differences between this and what you would see with a ReplicaSet. The first is that each replicated Pod has a numeric index (0, 1, ...), instead of the random suffix that is added by the ReplicaSet controller. The second is that the Pods are being slowly created in order, not all at once as they would be with a ReplicaSet.

Once the StatefulSet is created, we also need to create a “headless” service to manage the DNS entries for the StatefulSet. In Kubernetes a service is called “headless” if it doesn't have a cluster virtual IP address. Since with StatefulSets each Pod has a unique identity, it doesn't really make sense to have a load-balancing IP address for the replicated service. You can create a headless service using `clusterIP: None` in the service specification ([Example 15-11](#)).

Example 15-11. mongo-service.yaml

```
apiVersion: v1
kind: Service
metadata:
name: mongo
spec:
ports:
- port: 27017
name: peer
clusterIP: None
selector:
app: mongo
```

Once you create that service, there are usually four DNS entries that are populated. As usual, `mongo.default.svc.cluster.local` is created, but unlike with a standard service, doing a DNS lookup on this hostname provides all the addresses in the StatefulSet. In addition, entries are created for `mongo-0.mongo.default.svc.cluster.local` as well as `mongo-1.mongo` and `mongo-2.mongo`. Each of these resolves to the specific IP address of the replica index in the StatefulSet. Thus, with StatefulSets you get well-defined, persistent names for each replica in the set. This is often very useful when you are configuring a replicated storage solution. You can see these DNS entries in action by running the following commands in one of the Mongo replicas:

```
$ kubectl run -it --rm --image busybox busybox ping mongo-1.mongo
```

Next, we're going to manually set up Mongo replication using these per-Pod hostnames.

We'll choose `mongo-0.mongo` to be our initial primary. Run the `mongo` tool in that Pod:

```
$ kubectl exec -it mongo-0 mongo
> rs.initiate( {
  _id: "rs0",
  members:[ { _id: 0, host: "mongo-0.mongo:27017" } ]
});
OK
```

This command tells `mongodb` to initiate the ReplicaSet `rs0` with `mongo-0.mongo` as the primary replica.



The `rs0` name is arbitrary. You can use whatever you'd like, but you'll need to change it in the `mongo.yaml` StatefulSet definition as well.

Once you have initiated the Mongo ReplicaSet, you can add the remaining replicas by running the following commands in the `mongo` tool on the `mongo-0.mongo` Pod:

```
> rs.add("mongo-1.mongo:27017");
> rs.add("mongo-2.mongo:27017");
```

As you can see, we are using the replica-specific DNS names to add them as replicas in our Mongo cluster. At this point, we're done. Our replicated MongoDB is up and running. But it's really not as automated as we'd like it to be—in the next section, we'll see how to use scripts to automate the setup.

Automating MongoDB Cluster Creation

To automate the deployment of our StatefulSet-based MongoDB cluster, we're going to add an additional container to our Pods to perform the initialization.

To configure this Pod without having to build a new Docker image, we're going to use a ConfigMap to add a script into the existing MongoDB image. Here's the container we're adding:

```
...
- name: init-mongo
  image: mongo:3.4.1
  command:
  - bash
  - /config/init.sh
  volumeMounts:
  - name: config
    mountPath: /config
  volumes:
  - name: config
    configMap:
      name: "mongo-init"
```

Note that it is mounting a ConfigMap volume whose name is `mongo-init`. This ConfigMap holds a script that performs our initialization. First, the script determines whether it is running on `mongo-0` or not. If it is on `mongo-0`, it creates the ReplicaSet using the same command we ran imperatively previously. If it is on a different Mongo replica, it waits until the ReplicaSet exists, and then it registers itself as a member of that ReplicaSet.

[Example 15-12](#) has the complete ConfigMap object.

Example 15-12. mongo-configmap.yaml

```
apiVersion: v1
kind: ConfigMap
metadata:
  name: mongo-init
data:
  init.sh: |
    #!/bin/bash

    # Need to wait for the readiness health check to pass so that the
    # mongo names resolve. This is kind of wonky.
    until ping -c 1 ${HOSTNAME}.mongo; do
      echo "waiting for DNS (${HOSTNAME}.mongo)..."
      sleep 2
    done

    until /usr/bin/mongo --eval 'printjson(db.serverStatus())'; do
      echo "connecting to local mongo..."
      sleep 2
    done
    echo "connected to local."
```

```

HOST=mongo-0.mongo:27017

until /usr/bin/mongo --host=${HOST} --eval 'printjson(db.serverStatus())'; do
  echo "connecting to remote mongo..."
  sleep 2
done
echo "connected to remote."

if [[ "${HOSTNAME}" != 'mongo-0' ]]; then
  until /usr/bin/mongo --host=${HOST} --eval="printjson(rs.status())" \
    | grep -v "no replset config has been received"; do
    echo "waiting for replication set initialization"
    sleep 2
  done
  echo "adding self to mongo-0"
  /usr/bin/mongo --host=${HOST} \
    --eval="printjson(rs.add('${HOSTNAME}.mongo'))"
fi

if [[ "${HOSTNAME}" == 'mongo-0' ]]; then
  echo "initializing replica set"
  /usr/bin/mongo --eval="printjson(rs.initiate(\
    {'_id': 'rs0', 'members': [{'_id': 0, \
    'host': 'mongo-0.mongo:27017'}]}))"
fi
echo "initialized"

while true; do
  sleep 3600
done

```



This script currently sleeps forever after initializing the cluster. Every container in a Pod has to have the same RestartPolicy. Since we do not want our main Mongo container to be restarted, we need to have our initialization container run forever too, or else Kubernetes might think our Mongo Pod is unhealthy.

Putting it all together, [Example 15-13](#) is the complete StatefulSet that uses the ConfigMap.

Example 15-13. mongo.yaml

```

apiVersion: apps/v1
kind: StatefulSet
metadata:
  name: mongo
spec:
  serviceName: "mongo"
  replicas: 3
  template:

```

```

metadata:
  labels:
    app: mongo
spec:
  containers:
    - name: mongod
      image: mongo:3.4.1
      command:
        - mongod
        - --replSet
        - rs0
      ports:
        - containerPort: 27017
          name: web
    # This container initializes the mongod server, then sleeps.
    - name: init-mongo
      image: mongo:3.4.1
      command:
        - bash
        - /config/init.sh
      volumeMounts:
        - name: config
          mountPath: /config
  volumes:
    - name: config
      configMap:
        name: "mongo-init"

```

Given all of these files, you can create a Mongo cluster with:

```

$ kubectl apply -f mongo-config-map.yaml
$ kubectl apply -f mongo-service.yaml
$ kubectl apply -f mongo.yaml

```

Or if you want, you can combine them all into a single YAML file where the individual objects are separated by `---`. Ensure that you keep the same ordering, since the StatefulSet definition relies on the ConfigMap definition existing.

Persistent Volumes and StatefulSets

For persistent storage, you need to mount a persistent volume into the `/data/db` directory. In the Pod template, you need to update it to mount a persistent volume claim to that directory:

```

...
  volumeMounts:
    - name: database
      mountPath: /data/db

```

While this approach is similar to the one we saw with reliable singletons, because the StatefulSet replicates more than one Pod you cannot simply reference a persistent

volume claim. Instead, you need to add a *persistent volume claim template*. You can think of the claim template as being identical to the Pod template, but instead of creating Pods, it creates volume claims. You need to add the following onto the bottom of your StatefulSet definition:

```
volumeClaimTemplates:
- metadata:
  name: database
  annotations:
    volume.alpha.kubernetes.io/storage-class: anything
spec:
  accessModes: [ "ReadWriteOnce" ]
  resources:
    requests:
      storage: 100Gi
```

When you add a volume claim template to a StatefulSet definition, each time the StatefulSet controller creates a Pod that is part of the StatefulSet it will create a persistent volume claim based on this template as part of that Pod.



In order for these replicated persistent volumes to work correctly, you either need to have autoprovisioning set up for persistent volumes, or you need to prepopulate a collection of persistent volume objects for the StatefulSet controller to draw from. If there are no claims that can be created, the StatefulSet controller will not be able to create the corresponding Pods.

One Final Thing: Readiness Probes

The final piece in productionizing our MongoDB cluster is to add liveness checks to our Mongo-serving containers. As we learned in [“Health Checks” on page 54](#), the liveness probe is used to determine if a container is operating correctly. For the liveness checks, we can use the `mongo` tool itself by adding the following to the Pod template in the StatefulSet object:

```
...
livenessProbe:
  exec:
    command:
      - /usr/bin/mongo
      - --eval
      - db.serverStatus()
    initialDelaySeconds: 10
    timeoutSeconds: 10
...
```

Summary

Once we have combined StatefulSets, persistent volume claims, and liveness probing, we have a hardened, scalable cloud-native MongoDB installation running on Kubernetes. While this example dealt with MongoDB, the steps for creating StatefulSets to manage other storage solutions are quite similar and similar patterns can be followed.

Extending Kubernetes

From the beginning, it was clear that Kubernetes was going to be more than its core set of APIs; once an application is orchestrated within the cluster, there are countless other useful tools and utilities that can be represented and deployed as API objects in the Kubernetes cluster. The challenge was how to embrace this explosion of objects and use cases without having an API that sprawled without bound.

To resolve this tension between extended use cases and API sprawl, significant effort was put into making the Kubernetes API extensible. This extensibility meant that cluster operators could customize their clusters with the additional components that suited their needs. This extensibility enables people to augment their clusters themselves, consume community-developed cluster add-ons, and even develop extensions that are bundled and sold in an ecosystem of cluster plug-ins. Extensibility has also given rise to whole new patterns of managing systems, such as the operator pattern.

Regardless of whether you are building your own extensions or consuming operators from the ecosystem, understanding how the Kubernetes API server is extended and how extensions can be built and delivered is a key component to unlocking the complete power of Kubernetes and its ecosystem. As more and more advanced tools and platforms are built on top of Kubernetes using these extensibility mechanisms, a working knowledge of how they operate is critical to understanding how to build applications in a modern Kubernetes cluster.

What It Means to Extend Kubernetes

In general, extensions to the Kubernetes API server either add new functionality to a cluster or limit and tweak the ways that users can interact with their clusters. There is a rich ecosystem of plug-ins that cluster administrators can use to add additional services and capabilities to their clusters. It's worth noting that extending the cluster

is a very high-privilege thing to do. It is not a capability that should be extended to arbitrary users or arbitrary code, because cluster administrator privileges are required to extend a cluster. Even cluster administrators should be careful and use diligence when installing third-party tools. Some extensions, like admission controllers, can be used to view all objects being created in the cluster, and could easily be used as a vector to steal secrets or run malicious code. Additionally, extending a cluster makes it different than stock Kubernetes. When running on multiple clusters, it is very valuable to build tooling to maintain consistency of experience across the clusters, and this includes the extensions that are installed.

Points of Extensibility

There are many different ways to extend Kubernetes, from CustomResourceDefinitions through to Container Network Interface (CNI) plug-ins. This chapter is going to focus on the extensions to the API server via adding new resource types or admission controllers to API requests. We will not cover the CNI/CSI/CRI (Container Network Interface/Container Storage Interface/Container Runtime Interface) extensions, as they are more commonly used by Kubernetes cluster providers as opposed to the end users of Kubernetes, for whom this book was written.

In addition to admission controllers and API extensions, there are actually a number of ways to “extend” your cluster without ever modifying the API server at all. These include DaemonSets that install automatic logging and monitoring, tools that scan your services for cross-site scripting (XSS) vulnerabilities, and more. Before embarking on extending your cluster yourself, however, it’s worth considering the landscape of things that are possible within the confines of the existing Kubernetes APIs.

To help understand the role of admission controllers and CustomResourceDefinitions, it is very helpful to understand the flow of requests through the Kubernetes API server, which is shown in [Figure 16-1](#).

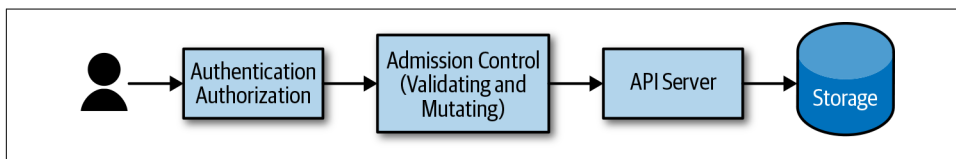

Figure 16-1. API server request flow

Admission controllers are called prior to the API object being written into the backing storage. Admission controllers can reject or modify API requests. There are several admission controllers that are built into the Kubernetes API server; for example, the limit range admission controller that sets default limits for Pods without them. Many other systems use custom admission controllers to auto-inject sidecar containers into all Pods created on the system to enable “auto-magic” experiences.

The other form of extension, which can also be used in conjunction with admission controllers, is custom resources. With custom resources, whole new API objects are added to the Kubernetes API surface area. These new API objects can be added to namespaces, are subject to RBAC, and can be accessed with existing tools like `kubectl` as well as via the Kubernetes API.

The following sections describe these Kubernetes extension points in greater detail and give both use cases and hands-on examples of how to extend your cluster.

The first thing that you do to create a custom resource is to create a `CustomResourceDefinition`. This object is actually a meta-resource; that is, a resource that is the definition of another resource.

As a concrete example, consider defining a new resource to represent load tests in your cluster. When a new `LoadTest` resource is created, a load test is spun up in your Kubernetes cluster and drives traffic to a service.

The first step in creating this new resource is defining it through a `CustomResourceDefinition`. An example definition looks as follows:

```
apiVersion: apiextensions.k8s.io/v1beta1
kind: CustomResourceDefinition
metadata:
  name: loadtests.beta.kuar.com
spec:
  group: beta.kuar.com
  versions:
    - name: v1
      served: true
      storage: true
  scope: Namespaced
  names:
    plural: loadtests
    singular: loadtest
    kind: LoadTest
    shortNames:
      - lt
```

You can see that this is a Kubernetes object like any other. It has a `metadata` subobject, and within that subobject the resource is named. However, in the case of custom resources, the name is special. It has to be the following format: `<resource-plural>.<api-group>`. The reason for this is to ensure that each resource definition is unique in the cluster, because the name of each `CustomResourceDefinition` has to match this pattern, and no two objects in the cluster can have the same name. We are thus guaranteed that no two `CustomResourceDefinitions` define the same resource.

In addition to `metadata`, the `CustomResourceDefinition` has a `spec` subobject. This is where the resource itself is defined. In that `spec` object, there is an `apiGroup` field which supplies the API group for the resource. As mentioned previously, it must

match the suffix of the CustomResourceDefinition's name. Additionally, there is a list of versions for the resource. In addition to the name of the version (e.g., v1, v2, etc.), there are fields that indicate if that version is served by the API server and which version is used for storing data in the backing storage for the API server. The `storage` field must be true for only a single version for the resource. There is also a `scope` field to indicate if the resource is namespaced or not (the default is namespaced), and a `names` field that allows for the definition of the singular, plural, and `kind` values for the resource. It also allows the definition of convenience “short names” for the resource for use in `kubectl` and elsewhere.

Given this definition, you can create the resource in the Kubernetes API server. But first, to show the true nature of dynamic resource types, try to list our `loadtests` resource using `kubectl`:

```
$ kubectl get loadtests
```

You'll see that there is no such resource currently defined.

Now use `loadtest-resource.yaml` to create this resource:

```
$ kubectl create -f loadtest-resource.yaml
```

Then get the `loadtests` resource again:

```
$ kubectl get loadtests
```

This time you'll see that there is a `LoadTest` resource type defined, though there are still no instances of this resource type.

Let's change that by creating a new `LoadTest` resource.

As with all built-in Kubernetes API objects, you can use YAML or JSON to define a custom resource (in this case our `LoadTest`). See the following definition:

```
apiVersion: beta.kuar.com/v1
kind: LoadTest
metadata:
  name: my-loadtest
spec:
  service: my-service
  scheme: https
  requestsPerSecond: 1000
  paths:
  - /index.html
  - /login.html
  - /shares/my-shares/
```

One thing that you'll note is that we never defined the schema for the custom resource in the CustomResourceDefinition. It actually is possible to provide an OpenAPI specification for a custom resource, but this complexity is generally not

worth it for simple resource types. If you do want to perform validation, you can register a validating admission controller, as described in the following sections.

You can now use this `loadtest.yaml` file to create a resource just like you would with any built-in type:

```
$ kubectl create -f loadtest.yaml
```

Now when you list the `loadtests` resource, you'll see your newly created resource:

```
$ kubectl get loadtests
```

This may be exciting, but it doesn't really do anything yet. Sure, you can use this simple CRUD (Create/Read/Update/Delete) API to manipulate the data for `LoadTest` objects, but no actual load tests are created in response to this new API we defined.

This is because there is no controller present in the cluster to react and take action when a `LoadTest` object is defined. The `LoadTest` custom resource is only half of the infrastructure needed to add `LoadTests` to our cluster. The other is a piece of code that will continuously monitor the custom resources and create, modify, or delete `LoadTests` as necessary to implement the API.

Just like the user of the API, the controller interacts with the API server to list `LoadTests` and watches for any changes that might occur. This interaction between controller and API server is shown in [Figure 16-2](#).

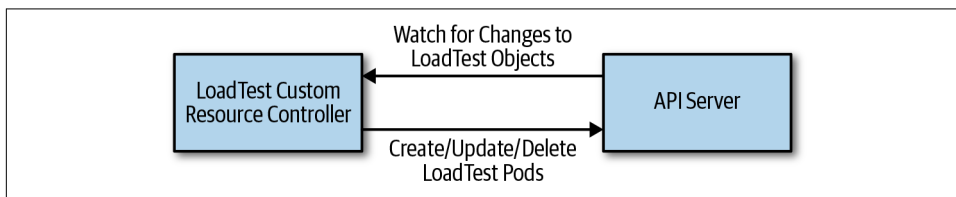

Figure 16-2. CustomResourceDefinition interactions

The code for such a controller can range from simple to complex. The simplest controllers run a `for` loop and repeatedly poll for new custom objects, and then take actions to create or delete the resources that implement those custom objects (e.g., the `LoadTest` worker pods).

However, this polling-based approach is inefficient: the period of the polling loop adds unnecessary latency, and the overhead of polling may add unnecessary load on the API server. A more efficient approach is to use the watch API on the API server, which provides a stream of updates when they occur, eliminating both the latency and overhead of polling. However, using this API correctly in a bug-free way is complicated. As a result, if you want to use watches, it is highly recommended that you use a well-supported mechanism such as the `Informer` pattern exposed in the [client-go](#) library.

Now that we have created a custom resource and implemented it via a controller, we have the basic functionality of a new resource in our cluster. However, many parts of what it means to be a well-functioning resource are missing. The two most important are validation and defaulting. Validation is the process of ensuring that LoadTest objects sent to the API server are well formed and can be used to create load tests, while defaulting makes it easier for people to use our resources by providing automatic, commonly used values by default. We'll now cover adding these capabilities to our custom resource.

As mentioned earlier, one option for adding validation is via an OpenAPI specification for our objects. This can be useful for basic validation of the presence of required fields or the absence of unknown fields. A complete OpenAPI tutorial is beyond the scope of this book, but there are lots of resources online, including the [complete Kubernetes API specification](#).

Generally speaking, an API schema is actually insufficient for validation of API objects. For example, in our `loadtests` example, we may want to validate that the LoadTest object has a valid scheme (e.g., `http` or `https`) or that `requestsPerSecond` is a nonzero positive number.

To accomplish this, we will use a validating admission controller. As discussed previously, admission controllers intercept requests to the API server before they are processed and can reject or modify the requests in flight. Admission controllers can be added to a cluster via the dynamic admission control system. A dynamic admission controller is a simple HTTP application. The API server connects to the admission controller via either a Kubernetes Service object or an arbitrary URL. This means that admission controllers can optionally run outside of the cluster—for example, in a cloud provider's Function-as-a-Service offering, like Azure Functions or AWS Lambda.

To install our validating admission controller, we need to specify it as a Kubernetes `ValidatingWebhookConfiguration`. This object specifies the endpoint where the admission controller runs, as well as the resource (in this case `LoadTest`) and the action (in this case `CREATE`) where the admission controller should be run. You can see the full definition for the validating admission controller in the following code:

```
apiVersion: admissionregistration.k8s.io/v1beta1
kind: ValidatingWebhookConfiguration
metadata:
  name: kuar-validator
webhooks:
- name: validator.kuar.com
  rules:
  - apiGroups:
    - "beta.kuar.com"
    apiVersions:
    - v1
```

```

operations:
- CREATE
resources:
- loadtests
clientConfig:
# Substitute the appropriate IP address for your webhook
url: https://192.168.1.233:8080
# This should be the base64-encoded CA certificate for your cluster,
# you can find it in your ${KUBECONFIG} file
caBundle: REPLACEME

```

Fortunately for security, but unfortunately for complexity, webhooks that are accessed by the Kubernetes API server can only be accessed via HTTPS. This means that we need to generate a certificate to serve the webhook. The easiest way to do this is to use the cluster's ability to generate new certificates using its own certificate authority (CA).

First, we need a private key and a certificate signing request (CSR). Here's a simple Go program that generates these:

```

package main

import (
    "crypto/rand"
    "crypto/rsa"
    "crypto/x509"
    "crypto/x509/pkix"
    "encoding/asn1"
    "encoding/pem"
    "net/url"
    "os"
)

func main() {
    host := os.Args[1]
    name := "server"

    key, err := rsa.GenerateKey(rand.Reader, 1024)
    if err != nil {
        panic(err)
    }
    keyDer := x509.MarshalPKCS1PrivateKey(key)
    keyBlock := pem.Block{
        Type: "RSA PRIVATE KEY",
        Bytes: keyDer,
    }
    keyFile, err := os.Create(name + ".key")
    if err != nil {
        panic(err)
    }
    pem.Encode(keyFile, &keyBlock)
    keyFile.Close()
}

```

```

commonName := "myuser"
emailAddress := "someone@myco.com"

org := "My Co, Inc."
orgUnit := "Widget Farmers"
city := "Seattle"
state := "WA"
country := "US"

subject := pkix.Name{
    CommonName:    commonName,
    Country:       []string{country},
    Locality:      []string{city},
    Organization:  []string{org},
    OrganizationalUnit: []string{orgUnit},
    Province:      []string{state},
}

uri, err := url.ParseRequestURI(host)
if err != nil {
    panic(err)
}

asn1, err := asn1.Marshal(subject.ToRDNSSequence())
if err != nil {
    panic(err)
}

csr := x509.CertificateRequest{
    RawSubject:    asn1,
    EmailAddresses: []string{emailAddress},
    SignatureAlgorithm: x509.SHA256WithRSA,
    URIs:          []*url.URL{uri},
}

bytes, err := x509.CreateCertificateRequest(rand.Reader, &csr, key)
if err != nil {
    panic(err)
}

csrFile, err := os.Create(name + ".csr")
if err != nil {
    panic(err)
}

pem.Encode(csrFile, &pem.Block{Type: "CERTIFICATE REQUEST", Bytes: bytes})
csrFile.Close()
}

```

You can run this program with:

```
$ go run csr-gen.go <URL-for-webook>
```

and it will generate two files, *server.csr* and *server-key.pem*.

You can then create a certificate signing request for the Kubernetes API server using the following YAML:

```
apiVersion: certificates.k8s.io/v1beta1
kind: CertificateSigningRequest
metadata:
  name: validating-controller.default
spec:
  groups:
  - system:authenticated
  request: REPLACEME
  usages:
  usages:
  - digital signature
  - key encipherment
  - key agreement
  - server auth
```

You will notice for the `request` field the value is `REPLACEME`; this needs to be replaced with the base64-encoded certificate signing request we produced in the preceding code:

```
$ perl -pi -e s/REPLACEME/$(base64 server.csr | tr -d '\n')/ \
admission-controller-csr.yaml
```

Now that your certificate signing request is ready, you can send it to the API server to get the certificate:

```
$ kubectl create -f admission-controller-csr.yaml
```

Next, you need to approve that request:

```
$ kubectl certificate approve validating-controller.default
```

Once approved, you can download the new certificate:

```
$ kubectl get csr validating-controller.default -o json | \
jq -r .status.certificate | base64 -d > server.crt
```

With the certificate, you are finally ready to create an SSL-based admission controller (phew!). When the admission controller code receives a request, it contains an object of type `AdmissionReview`, which contains metadata about the request as well as the body of the request itself. In our validating admission controller we have only registered for a single resource type and a single action (`CREATE`), so we don't need to examine the request metadata. Instead, we dive directly into the resource itself and validate that `requestsPerSecond` is positive and the URL scheme is valid. If they aren't, we return a JSON body disallowing the request.

Implementing an admission controller to provide defaulting is similar to the steps just described, but instead of using a `ValidatingWebhookConfiguration` you use a `MutatingWebhookConfiguration`, and you need to provide a `JSONPatch` object to mutate the request object before it is stored.

Here’s a TypeScript snippet that you can add to your validating admission controller to add defaulting. If the `paths` field in the `loadtest` is of length zero, add a single path for `/index.html`:

```
if (needsPatch(loadtest)) {
  const patch = [
    { 'op': 'add', 'path': '/spec/paths', 'value': ['/index.html'] },
  ]
  response['patch'] = Buffer.from(JSON.stringify(patch))
    .toString('base64');
  response['patchType'] = 'JSONPatch';
}
```

You can then register this webhook as a `MutatingWebhookConfiguration` by simply changing the `kind` field in the YAML object and saving the file as `mutating-controller.yaml`. Then create the controller by running:

```
$ kubectl create -f mutating-controller.yaml
```

At this point you’ve seen a complete example of how to extend the Kubernetes API server using custom resources and admission controllers. The following section describes some general patterns for various extensions.

Patterns for Custom Resources

Not all custom resources are identical. There are a variety of different reasons for extending the Kubernetes API surface area, and the following sections discuss some general patterns you may want to consider.

Just Data

The easiest pattern for API extension is the notion of “just data.” In this pattern, you are simply using the API server for storage and retrieval of information for your application. It is important to note that you should *not* use the Kubernetes API server for application data storage. The Kubernetes API server is not designed to be a key/value store for your app; instead, API extensions should be control or configuration objects that help you manage the deployment or runtime of your application. An example use case for the “just data” pattern might be configuration for canary deployments of your application—for example, directing 10% of all traffic to an experimental backend. While in theory such configuration information could also be stored in a `ConfigMap`, `ConfigMaps` are essentially untyped, and sometimes using a more strongly typed API extension object provides clarity and ease of use.

Extensions that are just data don’t need a corresponding controller to activate them, but they may have validating or mutating admission controllers to ensure that they are well formed. For example, in the canary use case a validating controller might ensure that all percentages in the canary object sum to 100%.

Compilers

A slightly more complicated pattern is the “compiler” or “abstraction” pattern. In this pattern the API extension object represents a higher-level abstraction that is “compiled” into a combination of lower-level Kubernetes objects. The `LoadTest` extension in the previous example is an example of this compiler abstraction pattern. A user consumes the extension as a high-level concept, in this case a `loadtest`, but it comes into being by being deployed as a collection of Kubernetes Pods and services. To achieve this, a compiled abstraction requires an API controller to be running somewhere in the cluster, to watch the current `LoadTests` and create the “compiled” representation (and likewise delete representations that no longer exist). In contrast to the operator pattern described next, however, there is no online health maintenance for compiled abstractions; it is delegated down to the lower-level objects (e.g., Pods).

Operators

While compiler extensions provide easy-to-use abstractions, extensions that use the “operator” pattern provide online, proactive management of the resources created by the extensions. These extensions likely provide a higher-level abstraction (for example, a database) that is compiled down to a lower-level representation, but they also provide online functionality, such as snapshot backups of the database, or upgrade notifications when a new version of the software is available. To achieve this, the controller not only monitors the extension API to add or remove things as necessary, but also monitors the running state of the application supplied by the extension (e.g., a database) and takes actions to remediate unhealthy databases, take snapshots, or restore from a snapshot if a failure occurs. Operators are the most complicated pattern for API extension of Kubernetes, but they are also the most powerful, enabling users to get easy access to “self-driving” abstractions that are responsible not just for deployment, but also health checking and repair.

Getting Started

Getting started extending the Kubernetes API can be a daunting and exhausting experience. Fortunately, there is a great deal of code to help you out. The [Kubebuilder project](#) contains a library of code intended help you easily build reliable Kubernetes API extensions. It’s a great resource to help you bootstrap your extension.

Summary

One of the great “superpowers” of Kubernetes is its ecosystem, and one of the most significant things powering this ecosystem is the extensibility of the Kubernetes API. Whether you’re designing your own extensions to customize your cluster or consuming off-the-shelf extensions as utilities, cluster services, or operators, API extensions

are the key to making your cluster your own and building the right environment for the rapid development of reliable applications.

Deploying Real-World Applications

The previous chapters described a variety of API objects that are available in a Kubernetes cluster and ways in which those objects can best be used to construct reliable distributed systems. However, none of the preceding chapters really discussed how you might use the objects in practice to deploy a complete, real-world application. That is the focus of this chapter.

We'll take a look at four real-world applications:

- Jupyter, an open source scientific notebook
- Parse, an open source API server for mobile applications
- Ghost, a blogging and content management platform
- Redis, a lightweight, performant key/value store

These complete examples should give you a better idea of how to structure your own deployments using Kubernetes.

Jupyter

The [Jupyter Project](#) is a web-based interactive scientific notebook for exploration and visualization. It is used by students and scientists around the world to build and explore data and data visualizations. Because it is both simple to deploy and interesting to use, it's a great first service to deploy on Kubernetes.

We begin by creating a namespace to hold the Jupyter application:

```
$ kubectl create namespace jupyter
```

And then create a deployment of size one with the program itself:

```
apiVersion: extensions/v1beta1
kind: Deployment
metadata:
  labels:
    run: jupyter
  name: jupyter
  namespace: jupyter
spec:
  replicas: 1
  selector:
    matchLabels:
      run: jupyter
  template:
    metadata:
      labels:
        run: jupyter
    spec:
      containers:
      - image: jupyter/scipy-notebook:abdb27a6dfbb
        name: jupyter
      dnsPolicy: ClusterFirst
      restartPolicy: Always
```

Create a file named *jupyter.yaml* with these contents. Once you have created this file, you can deploy it using:

```
$ kubectl create -f jupyter.yaml
```

Now you need to wait for the container to be created. The Jupyter container is quite large (2 GB at the time of writing), and thus it may take a few minutes to start up.

You can wait for the container to become ready using the `watch` command (on macOS, you'll need to install this command using `brew install watch`):

```
$ watch kubectl get pods --namespace jupyter
```

Once the Jupyter container is up and running, you need to obtain the initial login token. You can do this by looking at the logs for the container:

```
$ pod_name=$(kubectl get pods --namespace jupyter --no-headers | awk '{print $1}') \
  kubectl logs --namespace jupyter ${pod_name}
```

You should then copy the token (it will look something like `/?token=0195713c8e65088650fdd8b599db377b7ce6c9b10bd13766`).

Next, set up port forwarding to the Jupyter container:

```
$ kubectl port-forward ${pod_name} 8888:8888
```

Finally, you can visit `http://localhost:8888/?token=<token>`, inserting the token that you copied from the logs earlier.

You should now have the Jupyter dashboard loaded in your browser. You can find tutorials to get oriented to Jupyter if you are so inclined on the [Jupyter project site](#).

Parse

The [Parse server](#) is a cloud API dedicated to providing easy-to-use storage for mobile applications. It provides a variety of different client libraries that make it easy to integrate with Android, iOS, and other mobile platforms. Parse was purchased by Facebook in 2013 and subsequently shut down. Fortunately for us, a compatible server was open sourced by the core Parse team and is available for us to use. This section describes how to set up Parse in Kubernetes.

Prerequisites

Parse uses a MongoDB cluster for its storage. [Chapter 15](#) described how to set up a replicated MongoDB cluster using Kubernetes StatefulSets. This section assumes you have a three-replica Mongo cluster running in Kubernetes with the names `mongo-0.mongo`, `mongo-1.mongo`, and `mongo-2.mongo`.

These instructions also assume that you have a Docker login; if you don't have one, you can get one for free at <https://docker.com>.

Finally, we assume you have a Kubernetes cluster deployed and the `kubectl` tool properly configured.

Building the parse-server

The open source `parse-server` comes with a Dockerfile by default, for easy containerization. First, clone the Parse repository:

```
$ git clone https://github.com/ParsePlatform/parse-server
```

Then move into that directory and build the image:

```
$ cd parse-server
$ docker build -t ${DOCKER_USER}/parse-server .
```

Finally, push that image up to the Docker hub:

```
$ docker push ${DOCKER_USER}/parse-server
```

Deploying the parse-server

Once you have the container image built, deploying the `parse-server` into your cluster is fairly straightforward. Parse looks for three environment variables when being configured:

PARSE_SERVER_APPLICATION_ID

An identifier for authorizing your application

PARSE_SERVER_MASTER_KEY

An identifier that authorizes the master (root) user

PARSE_SERVER_DATABASE_URI

The URI for your MongoDB cluster

Putting this all together, you can deploy Parse as a Kubernetes deployment using the YAML file in [Example 17-1](#).

Example 17-1. parse.yaml

```
apiVersion: extensions/v1beta1
kind: Deployment
metadata:
  name: parse-server
  namespace: default
spec:
  replicas: 1
  template:
    metadata:
      labels:
        run: parse-server
    spec:
      containers:
      - name: parse-server
        image: ${DOCKER_USER}/parse-server
        env:
        - name: PARSE_SERVER_DATABASE_URI
          value: "mongodb://mongo-0.mongo:27017,\
            mongo-1.mongo:27017,mongo-2.mongo\
            :27017/dev?replicaSet=rs0"
        - name: PARSE_SERVER_APP_ID
          value: my-app-id
        - name: PARSE_SERVER_MASTER_KEY
          value: my-master-key
```

Testing Parse

To test your deployment, you need to expose it as a Kubernetes service. You can do that using the service definition in [Example 17-2](#).

Example 17-2. parse-service.yaml

```
apiVersion: v1
kind: Service
metadata:
```

```
name: parse-server
namespace: default
spec:
  ports:
  - port: 1337
    protocol: TCP
    targetPort: 1337
  selector:
    run: parse-server
```

Now your Parse server is up and running and ready to receive requests from your mobile applications. Of course, in any real application you are likely going to want to secure the connection with HTTPS. You can see the [parse-server GitHub page](#) for more details on such a configuration.

Ghost

Ghost is a popular blogging engine with a clean interface written in JavaScript. It can either use a file-based SQLite database or MySQL for storage.

Configuring Ghost

Ghost is configured with a simple JavaScript file that describes the server. We will store this file as a configuration map. A simple development configuration for Ghost looks like [Example 17-3](#).

Example 17-3. ghost-config.js

```
var path = require('path'),
    config;

config = {
  development: {
    url: 'http://localhost:2368',
    database: {
      client: 'sqlite3',
      connection: {
        filename: path.join(process.env.GHOST_CONTENT,
                              '/data/ghost-dev.db')
      },
      debug: false
    },
  },
  server: {
    host: '0.0.0.0',
    port: '2368'
  },
  paths: {
    contentPath: path.join(process.env.GHOST_CONTENT, '/')
  }
}
```



```
    }  
};  
  
module.exports = config;
```

Once you have this configuration file saved to *ghost-config.js*, you can create a Kubernetes ConfigMap object using:

```
$ kubectl create cm --from-file ghost-config.js ghost-config
```

This creates a ConfigMap that is named *ghost-config*. As with the Parse example, we will mount this configuration file as a volume inside of our container. We will deploy Ghost as a Deployment object, which defines this volume mount as part of the Pod template ([Example 17-4](#)).

Example 17-4. ghost.yaml

```
apiVersion: extensions/v1beta1  
kind: Deployment  
metadata:  
  name: ghost  
spec:  
  replicas: 1  
  selector:  
    matchLabels:  
      run: ghost  
  template:  
    metadata:  
      labels:  
        run: ghost  
    spec:  
      containers:  
        - image: ghost  
          name: ghost  
          command:  
            - sh  
            - -c  
            - cp /ghost-config/ghost-config.js /var/lib/ghost/config.js  
              && /usr/local/bin/docker-entrypoint.sh node current/index.js  
          volumeMounts:  
            - mountPath: /ghost-config  
              name: config  
      volumes:  
        - name: config  
          configMap:  
            defaultMode: 420  
            name: ghost-config
```

One thing to note here is that we are copying the `config.js` file from a different location into the location where Ghost expects to find it, since the ConfigMap can only mount directories, not individual files. Ghost expects other files that are not in that ConfigMap to be present in its directory, and thus we cannot simply mount the entire ConfigMap into `/var/lib/ghost`.

You can run this with:

```
$ kubectl apply -f ghost.yaml
```

Once the Pod is up and running, you can expose it as a service with:

```
$ kubectl expose deployments ghost --port=2368
```

Once the service is exposed, you can use the `kubectl proxy` command to access the Ghost server:

```
$ kubectl proxy
```

Then visit <http://localhost:8001/api/v1/namespaces/default/services/ghost/proxy/> in your web browser to begin interacting with Ghost.

Ghost + MySQL

Of course, this example isn't very scalable, or even reliable, since the contents of the blog are stored in a local file inside the container. A more scalable approach is to store the blog's data in a MySQL database.

To do this, first modify `config.js` to include:

```
...
database: {
  client: 'mysql',
  connection: {
    host      : 'mysql',
    user      : 'root',
    password  : 'root',
    database  : 'ghost_db',
    charset   : 'utf8'
  }
},
...
```

Obviously, in a real-world deployment you'll want to change the password from `root` to something more secret.

Next, create a new `ghost-config` ConfigMap object:

```
$ kubectl create configmap ghost-config-mysql --from-file ghost-config.js
```

Then update the Ghost deployment to change the name of the ConfigMap mounted from `config-map` to `config-map-mysql`:

```
...
  - configMap:
    name: ghost-config-mysql
...

```

Using the instructions from “[Kubernetes-Native Storage with StatefulSets](#)” on page 186, deploy a MySQL server in your Kubernetes cluster. Make sure that it has a service named `mysql` defined as well.

You will need to create the database in the MySQL database:

```
$ kubectl exec -it mysql-zzmlw -- mysql -u root -p
Enter password:
Welcome to the MySQL monitor.  Commands end with ; or \g.
...

mysql> create database ghost_db;
...

```

Finally, perform a rollout to deploy this new configuration:

```
$ kubectl apply -f ghost.yaml
```

Because your Ghost server is now decoupled from its database, you can scale up your Ghost server and it will continue to share the data across all replicas.

Edit `ghost.yaml` to set `spec.replicas` to 3, then run:

```
$ kubectl apply -f ghost.yaml
```

Your Ghost installation is now scaled up to three replicas.

Redis

Redis is a popular in-memory key/value store, with numerous additional features. It’s an interesting application to deploy because it is a good example of the value of the Kubernetes Pod abstraction. This is because a reliable Redis installation actually is two programs working together. The first is `redis-server`, which implements the key/value store, and the other is `redis-sentinel`, which implements health checking and failover for a replicated Redis cluster.

When Redis is deployed in a replicated manner, there is a single master server that can be used for both read and write operations. Additionally, there are other replica servers that duplicate the data written to the master and can be used for load-balancing read operations. Any of these replicas can fail over to become the master if the original master fails. This failover is performed by the Redis sentinel. In our deployment, both a Redis server and a Redis sentinel are colocated in the same file.

Configuring Redis

As before, we're going to use Kubernetes ConfigMaps to configure our Redis installation. Redis needs separate configurations for the master and slave replicas. To configure the master, create a file named *master.conf* that contains the code in [Example 17-5](#).

Example 17-5. master.conf

```
bind 0.0.0.0
port 6379

dir /redis-data
```

This directs Redis to bind to all network interfaces on port 6379 (the default Redis port) and store its files in the */redis-data* directory.

The slave configuration is identical, but it adds a single `slaveof` directive. Create a file named *slave.conf* that contains what's in [Example 17-6](#).

Example 17-6. slave.conf

```
bind 0.0.0.0
port 6379

dir .

slaveof redis-0.redis 6379
```

Notice that we are using `redis-0.redis` for the name of the master. We will set up this name using a service and a StatefulSet.

We also need a configuration for the Redis sentinel. Create a file named *sentinel.conf* with the contents of [Example 17-7](#).

Example 17-7. sentinel.conf

```
bind 0.0.0.0
port 26379

sentinel monitor redis redis-0.redis 6379 2
sentinel parallel-syncs redis 1
sentinel down-after-milliseconds redis 10000
sentinel failover-timeout redis 20000
```

Now that we have all of our configuration files, we need to create a couple of simple wrapper scripts to use in our StatefulSet deployment.

The first script simply looks at the hostname for the Pod and determines whether this is the master or a slave, and launches Redis with the appropriate configuration. Create a file named *init.sh* containing the code in [Example 17-8](#).

Example 17-8. init.sh

```
#!/bin/bash
if [[ ${HOSTNAME} == 'redis-0' ]]; then
    redis-server /redis-config/master.conf
else
    redis-server /redis-config/slave.conf
fi
```

The other script is for the sentinel. In this case it is necessary because we need to wait for the `redis-0.redis` DNS name to become available. Create a script named *sentinel.sh* containing the code in [Example 17-9](#).

Example 17-9. sentinel.sh

```
#!/bin/bash
cp /redis-config-src/*.* /redis-config

while ! ping -c 1 redis-0.redis; do
    echo 'Waiting for server'
    sleep 1
done

redis-sentinel /redis-config/sentinel.conf
```

Now we need to package all of these files into a ConfigMap object. You can do this with a single command line:

```
$ kubectl create configmap \
  --from-file=slave.conf=./slave.conf \
  --from-file=master.conf=./master.conf \
  --from-file=sentinel.conf=./sentinel.conf \
  --from-file=init.sh=./init.sh \
  --from-file=sentinel.sh=./sentinel.sh \
  redis-config
```

Creating a Redis Service

The next step in deploying Redis is to create a Kubernetes service that will provide naming and discovery for the Redis replicas (e.g., `redis-0.redis`). To do this, we create a service without a cluster IP address ([Example 17-10](#)).

Example 17-10. redis-service.yaml

```
apiVersion: v1
kind: Service
metadata:
  name: redis
spec:
  ports:
    - port: 6379
      name: peer
  clusterIP: None
  selector:
    app: redis
```

You can create this service with `kubectl apply -f redis-service.yaml`. Don't worry that the Pods for the service don't exist yet. Kubernetes doesn't care; it will add the right names when the Pods are created.

Deploying Redis

We're ready to deploy our Redis cluster. To do this we're going to use a StatefulSet. We introduced StatefulSets in “[Manually Replicated MongoDB with StatefulSets](#)” on page 187, when we discussed our MongoDB installation. StatefulSets provide indexing (e.g., `redis-0.redis`) as well as ordered creation and deletion semantics (`redis-0` will always be created before `redis-1`, and so on). They're quite useful for stateful applications like Redis, but honestly, they basically look like Kubernetes deployments. [Example 17-11](#) shows what the StatefulSet looks like for our Redis cluster.

Example 17-11. redis.yaml

```
apiVersion: apps/v1beta1
kind: StatefulSet
metadata:
  name: redis
spec:
  replicas: 3
  serviceName: redis
  template:
    metadata:
      labels:
        app: redis
    spec:
      containers:
        - command: [sh, -c, source /redis-config/init.sh ]
          image: redis:4.0.11-alpine
          name: redis
          ports:
            - containerPort: 6379
              name: redis
```

```

    volumeMounts:
      - mountPath: /redis-config
        name: config
      - mountPath: /redis-data
        name: data
  - command: [sh, -c, source /redis-config-src/sentinel.sh]
    image: redis:4.0.11-alpine
    name: sentinel
    volumeMounts:
      - mountPath: /redis-config-src
        name: config
      - mountPath: /redis-config
        name: data
  volumes:
  - configMap:
      defaultMode: 420
      name: redis-config
    name: config
  - emptyDir:
      name: data
    volumeMounts:
      - mountPath: /redis-config
        name: config
      - mountPath: /redis-data
        name: data
  - command: [sh, -c, source /redis-config/sentinel.sh]
    image: redis:3.2.7-alpine
    name: sentinel
    volumeMounts:
      - mountPath: /redis-config
        name: config

```

You can see that there are two containers in this Pod. One runs the *init.sh* script that we created and the main Redis server, and the other is the sentinel that monitors the servers.

You can also see that there are two volumes defined in the Pod. One is the volume that uses our ConfigMap to configure the two Redis applications, and the other is a simple `emptyDir` volume that is mapped into the Redis server container to hold the application data so that it survives a container restart. For a more reliable Redis installation, this could be a network-attached disk, as discussed in [Chapter 15](#).

Now that we've defined our Redis cluster, we can create it using:

```
$ kubectl apply -f redis.yaml
```

Playing with Our Redis Cluster

To demonstrate that we've actually successfully created a Redis cluster, we can perform some tests.

First, we can determine which server the Redis sentinel believes is the master. To do this, we can run the `redis-cli` command in one of the Pods:

```
$ kubectl exec redis-2 -c redis \  
-- redis-cli -p 26379 sentinel get-master-addr-by-name redis
```

This should print out the IP address of the `redis-0` Pod. You can confirm this using `kubectl get pods -o wide`.

Next, we'll confirm that the replication is actually working.

To do this, first try to read the value `foo` from one of the replicas:

```
$ kubectl exec redis-2 -c redis -- redis-cli -p 6379 get foo
```

You should see no data in the response.

Next, try to write that data to a replica:

```
$ kubectl exec redis-2 -c redis -- redis-cli -p 6379 set foo 10  
READONLY You can't write against a read only slave.
```

You can't write to a replica, because it's read-only. Let's try the same command against `redis-0`, which is the master:

```
$ kubectl exec redis-0 -c redis -- redis-cli -p 6379 set foo 10  
OK
```

Now try the original read from a replica:

```
$ kubectl exec redis-2 -c redis -- redis-cli -p 6379 get foo  
10
```

This shows that our cluster is set up correctly, and data is replicating between masters and slaves.

Summary

In this chapter we described how to deploy a variety of applications using assorted Kubernetes concepts. We saw how to put together service-based naming and discovery to deploy web frontends like Ghost as well as API servers like Parse, and we saw how Pod abstraction makes it easy to deploy the components that make up a reliable Redis cluster. Regardless of whether you will actually deploy these applications to production, the examples demonstrated patterns that you can repeat to manage your applications using Kubernetes. We hope that seeing the concepts we described in previous chapters come to life in real-world examples helps you better understand how to make Kubernetes work for you.

Organizing Your Application

Throughout this book we have described various components of an application built on top of Kubernetes. We have described how to wrap programs up as containers, place those containers in Pods, replicate those Pods with ReplicaSets, and roll out software each week with deployments. We have even described how to deploy stateful and real-world applications that put together a collection of these objects into a single distributed system. But we have not covered how to actually work with such an application in a practical way. How can you lay out, share, manage, and update the various configurations that make up your application? That is the topic for this chapter.

Principles to Guide Us

Before digging into the concrete details of how to structure your application, it's worth considering the goals that drive this structure. Obviously, reliability and agility are the general goals of developing a cloud-native application in Kubernetes, but moving to the next level of detail, how does this actually relate to how you design the maintenance and deployment of your application? The following sections describe the various principles that we can use as a guide to design a structure that best suits these goals. The principles are:

- Filesystems as the source of truth
- Code review to ensure the quality of changes
- Feature flags for staged roll forward and roll back

Filesystems as the Source of Truth

When you first begin to explore Kubernetes, as we did in the beginning of this book, you generally interact with it imperatively. You run commands like `kubectl run` or `kubectl edit` to create and modify Pods or other objects running in your cluster. Even when we started exploring how to write and use YAML or JSON files, this was presented in an ad-hoc manner, as if the file itself is just a way station on the way to modifying the state of the cluster. In reality, in a true productionized application the opposite should be true.

Rather than viewing the state of the cluster—the data in `etcd`—as the source of truth, it is optimal to view the filesystem of YAML objects as the source of truth for your application. The API objects deployed into your Kubernetes cluster(s) are then a reflection of the truth stored in the filesystem.

There are numerous reasons why this is the right point of view. The first and foremost is that it largely enables you to treat your cluster as if it is immutable infrastructure. As we have moved into cloud-native architectures, we have become increasingly comfortable with the notion that our applications and their containers are immutable infrastructure, but treating a cluster as such is less common. And yet, the same reasons for moving our applications to immutable infrastructure apply to our clusters. If your cluster is a snowflake made up by the ad-hoc application of various random YAML files downloaded from the internet, it is as dangerous as a virtual machine that has been built from imperative bash scripts.

Additionally, managing the cluster state via the filesystem makes it very easy to collaborate with multiple team members. Source-control systems are well understood and can easily enable multiple different people to simultaneously edit the state of the cluster while making conflicts (and the resolution of those conflicts) clear to everyone.



The combination of these motivations means that it is absolutely a first principle that all applications deployed to Kubernetes should first be described in files stored in a filesystem. The actual API objects are then just a projection of this filesystem into a particular cluster.

The Role of Code Review

It wasn't long ago that code review for application source code was a novel idea. But it is clear now that the notion of multiple people looking at a piece of code before it is committed to an application is a best practice for producing quality, reliable code.

It is therefore surprising that the same is somewhat less true for the configurations used to deploy those applications. All of the same reasons for reviewing code apply

directly to application configurations also. But when you think about it, it is also obvious that code review of these configurations is critical to the reliable deployment of services. In our experience, most service outages are self-inflicted via unexpected consequences, typos, or other simple mistakes. Ensuring that at least two people look at any configuration change significantly decreases the probability of such errors.



Consequently, the second principle of our application layout is that it must facilitate the review of every change merged into the set of files that represents the source of truth for our cluster.

Feature Gates and Guards

Once your application source code and your deployment configuration files are in source control, one of the most common questions that occurs is how these repositories relate to one another. Should you use the same repository for application source code as well as configuration? This can work for small projects, but in larger projects it often makes sense to separate the source code from the configuration to provide for a separation of concerns. Even if the same people are responsible for both building and deploying the application, the perspectives of the builder versus the deployer are different enough that this separation of concerns makes sense.

If that is the case, then how do you bridge the development of new features in source control with the deployment of those features into a production environment? This is where feature gates and guards play an important role.

The idea is that when some new feature is developed, that development takes place entirely behind a feature flag or gate. This gate looks something like:

```
if (featureFlags.myFlag) {  
  // Feature implementation goes here  
}
```

There are a variety of benefits to this approach. First, it enables the committing of code to the production branch long before the feature is ready to ship. This enables feature development to stay much more closely aligned with the HEAD of a repository, and thus you avoid the horrendous merge conflicts of a long-lived branch.

Additionally, it means that the enabling a feature simply involves a configuration change to activate the flag. This makes it very clear what changed in the production environment, and likewise makes it very simple to roll back the activation of the feature if it causes problems.

The use of feature flags thus both simplifies debugging problems in production and ensures that disabling a feature doesn't require a binary rollback to an older version of

the code that would remove all of the bug fixes and other improvements made by the newer version of the code.



The third principle of application layout is that code lands in source control, by default off, behind a feature flag, and is only activated through a code-reviewed change to configuration files.

Managing Your Application in Source Control

Now that we have determined that the filesystem should represent the source of truth for your cluster, the next important question is how to actually lay out the files in the filesystem. Obviously, filesystems contain hierarchical directories, and a source-control system adds concepts like tags and branches, so this section describes how to put these together to represent and manage your application.

Filesystem Layout

For the purposes of this section, we will describe how to lay out an instance of your application for a single cluster. In later sections we will describe how to parameterize this layout for multiple instances of your application. It's worth noting that this organization is worth getting right when you begin. Much like modifying the layout of packages in source control, modifying your deployment configurations after the fact is a complicated and expensive refactor that you'll probably never get around to.

The first cardinality on which you want to organize your application is the semantic component or layer (e.g., *frontend*, *batch work queue*, etc.). Though early on this might seem like overkill, since a single team manages all of these components, it sets the stage for team scaling—eventually, a different team (or subteam) may be responsible for each of these components.

Thus, for an application with a frontend that uses two services, the filesystem might look like:

```
frontend/  
  service-1/  
  service-2/
```

Within each of these directories, the configurations for each application are stored. These are the YAML files that directly represent the current state of the cluster. It's generally useful to include both the service name and the object type within the same file.



While Kubernetes allows for the creation of YAML files with multiple objects in the same file, this should generally be considered an anti-pattern. The only good reason for grouping a number of objects in the same file is if they are conceptually identical. When deciding what to include in a single YAML file, consider design principles similar to those for defining a class or struct. If grouping the objects together doesn't form a single concept, they probably shouldn't be in a single file.

Thus, extending our previous example, the filesystem might look like:

```
frontend/  
  frontend-deployment.yaml  
  frontend-service.yaml  
  frontend-ingress.yaml  
service-1/  
  service-1-deployment.yaml  
  service-1-service.yaml  
  service-1-configmap.yaml  
...
```

Managing Periodic Versions

The previous section described a file structure for laying out the various tiers in your application, but what about managing the releases of your application? It is very useful to be able to look back historically and see what your application deployment previously looked like. Similarly, it is very useful to be able to iterate a configuration forward while still being able to deploy a stable release configuration.

Consequently, it's handy to be able to simultaneously store and maintain multiple different revisions of your configuration. Given the file and version control approach, there are two different approaches that you can use. The first is to use tags, branches, and source-control features. This is convenient because it maps to the same way that people manage revisions in source control, and it leads to a more simplified directory structure. The other option is to clone the configuration within the filesystem and use directories for different revisions. This approach is convenient because it makes simultaneous viewing of the configurations very straightforward.

In reality, the approaches are more or less identical, and it is ultimately an aesthetic choice between the two. Thus, we will discuss both approaches and let you or your team decide which you prefer.

Versioning with branches and tags

When you use branches and tags to manage configuration revisions, the directory structure is unchanged from the example in the previous section. When you are ready for a release, you place a source-control tag (e.g., `git tag v1.0`) in the configu-

ration source-control system. The tag represents the configuration used for that version, and the HEAD of source control continues to iterate forward.

The world becomes somewhat more complicated when you need to update the release configuration, but the approach models what you would do in source control. First, you commit the change to the HEAD of the repository. Then you create a new branch named `v1` at the `v1.0` tag. You then cherry-pick the desired change onto the release branch (`git cherry-pick <edit>`), and finally, you tag this branch with the `v1.1` tag to indicate a new point release.



One common error when cherry-picking fixes into a release branch is to only pick the change into the latest release. It's a good idea to cherry-pick it into all active releases, in case for some reason you need to roll back versions but the fix is still needed.

Versioning with directories

An alternative to using source-control features is to use filesystem features. In this approach, each versioned deployment exists within its own directory. For example, the filesystem for your application might look like this:

```
frontend/  
  v1/  
    frontend-deployment.yaml  
    frontend-service.yaml  
  current/  
    frontend-deployment.yaml  
    frontend-service.yaml  
service-1/  
  v1/  
    service-1-deployment.yaml  
    service-1-service.yaml  
  v2/  
    service-1-deployment.yaml  
    service-1-service.yaml  
  current/  
    service-1-deployment.yaml  
    service-1-service.yaml  
...
```

Thus, each revision exists in a parallel directory structure within a directory associated with the release. All deployments occur from HEAD instead of from specific revisions or tags. When adding a new configuration, it is done to the files in the *current* directory.

When creating a new release, the *current* directory is copied to create a new directory associated with the new release.

When performing a bugfix change to a release, the pull request must modify the YAML file in all the relevant release directories. This is a slightly better experience than the cherry-picking approach described earlier, since it is clear in a single change request that all of the relevant versions are being updated with the same change, instead of requiring a cherry-pick per version.

Structuring Your Application for Development, Testing, and Deployment

In addition to structuring your application for a periodic release cadence, you also want to structure your application to enable agile development, quality testing, and safe deployment. This enables developers to rapidly make and test changes to the distributed application, and to safely roll those changes out to customers.

Goals

There are two goals for your application with regard to development and testing. The first is that each developer should be able to easily develop new features for the application. In most cases, the developer is only working on a single component, and yet that component is interconnected to all of the other microservices within the cluster. Thus, to facilitate development it is essential that developers be able to work in their own environment, yet with all services available.

The other goal for structuring your application for testing is the ability to easily and accurately test your application prior to deployment. This is essential to the ability to quickly roll out features while maintaining high reliability.

Progression of a Release

To achieve both of these goals, it is important to relate the stages of development to the release versions described earlier. The stages of a release are:

HEAD

The bleeding edge of the configuration; the latest changes.

Development

Largely stable, but not ready for deployment. Suitable for developers to use for building features.

Staging

The beginnings of testing, unlikely to change unless problems are found.

Canary

The first real release to users, used to test for problems with real-world traffic and likewise give users a chance to test what is coming next.

Release

The current production release.

Introducing a development tag

Regardless of whether you structure releases using the filesystem or version control, the right way to model the development stage is via a source-control tag. This is because development is necessarily fast-moving as it tracks stability only slightly behind HEAD.

To introduce a development stage, a new development tag is added to the source-control system and an automated process is used to move this tag forward. On a periodic cadence, HEAD is tested via automated integration testing. If these tests pass, the development tag is moved forward to HEAD. Thus, developers can track reasonably close to the latest changes when deploying their own environments, but they also can be assured that the deployed configurations have at least passed a limited smoke test.

Mapping stages to revisions

It might be tempting to introduce a new set of configurations for each of these stages, but in reality, the Cartesian product of versions and stages would create a mess that is very difficult to reason about. Instead, the right practice is to introduce a mapping between revisions and stages.

Regardless of whether you are using the filesystem or source-control revisions to represent different configuration versions, it is easy to implement a map from stage to revision. In the filesystem case you can use symbolic links to map a stage name to a revision:

```
frontend/  
  canary/ -> v2/  
  release/ -> v1/  
  v1/  
    frontend-deployment.yaml  
  ...
```

In the case of version control, it is simply an additional tag at the same revision as the appropriate version.

In either case, the versioning of releases proceeds using the processes described previously, and separately the stages are moved forward to new versions as appropriate. Effectively this means that there are two simultaneous processes, the first for cutting new release versions and the second for qualifying a release version for a particular stage in the application lifecycle.

Parameterizing Your Application with Templates

Once you have a Cartesian product of environments and stages, it becomes clear that it is impractical or impossible to keep them all entirely identical. And yet, it is important to strive for the environments to be as identical as possible. Variance and drift between different environments produces snowflakes and systems that are hard to reason about. If your staging environment is different than your release environment, can you really trust the load tests that you ran in the staging environment to qualify a release? To ensure that your environments stay as similar as possible, it is useful to use parameterized environments. Parameterized environments use *templates* for the bulk of their configuration, but they mix in a limited set of *parameters* to produce the final configuration. In this way most of the configuration is contained within a shared template, while the parameterization is limited in scope and maintained in a small parameters file for easy visualization of differences between environments.

Parameterizing with Helm and Templates

There are a variety of different languages for creating parameterized configurations. In general they all divide the files into a *template* file, which contains the bulk of the configuration, and a *parameters* file, which can be combined with the template to produce a complete configuration. In addition to parameters, most templating languages allow parameters to have default values if no value is specified.

The following gives examples of how to parameterize configurations using [Helm](#), a package manager for Kubernetes. Despite what devotees of various languages may say, all parameterization languages are largely equivalent, and as with programming languages, which one you prefer is largely a matter of personal or team style. Thus, the same patterns described here for Helm apply regardless of the templating language you choose.

The Helm template language uses the “mustache” syntax, so for example:

```
metadata:
  name: {{ .Release.Name }}-deployment
```

indicates that `Release.Name` should be substituted into the name of a deployment.

To pass a parameter for this value you use a *values.yaml* file with contents like:

```
Release:
  Name: my-release
```

Which after parameter substitution results in:

```
metadata:
  name: my-release-deployment
```

Filesystem Layout for Parameterization

Now that you understand how to parameterize your configurations, how do you apply that to the filesystem layouts we have described previously? To achieve this, instead of treating each deployment lifecycle stage as a pointer to a version, each deployment lifecycle is the combination of a parameters file and a pointer to a specific version. For example, in a directory-based layout this might look like:

```
frontend/  
  staging/  
    templates -> ../v2  
    staging-parameters.yaml  
  production/  
    templates -> ../v1  
    production-parameters.yaml  
  v1/  
    frontend-deployment.yaml  
    frontend-service.yaml  
  v2/  
    frontend-deployment.yaml  
    frontend-service.yaml  
  ...
```

Doing this with version control looks similar, except that the parameters for each lifecycle stage are kept at the root of the configuration directory tree:

```
frontend/  
  staging-parameters.yaml  
  templates/  
    frontend-deployment.YAML  
  ....
```

Deploying Your Application Around the World

Now that you have multiple versions of your application moving through multiple stages of deployment, the final step in structuring your configurations is to deploy your application around the world. But don't think that these approaches are only for large-scale applications. In reality, they can be used to scale from two different regions to tens or hundreds around the world. In the world of the cloud, where an entire region can fail, deploying to multiple regions (and managing that deployment) is the only way to achieve sufficient uptime for demanding users.

Architectures for Worldwide Deployment

Generally speaking, each Kubernetes cluster is intended to live in a single region, and each Kubernetes cluster is expected to contain a single, complete deployment of your application. Consequently, a worldwide deployment of an application consists of multiple different Kubernetes clusters, each with its own application configuration.

Describing how to actually build a worldwide application, especially with complex subjects like data replication, is beyond the scope of this chapter, but we will describe how to arrange the application configurations in the filesystem.

Ultimately, a particular region's configuration is conceptually the same as a stage in the deployment lifecycle. Thus, adding multiple regions to your configuration is identical to adding new lifecycle stages. For example, instead of:

- Development
- Staging
- Canary
- Production

You might have:

- Development
- Staging
- Canary
- EastUS
- WestUS
- Europe
- Asia

Modeling this in the filesystem for configuration, this looks like:

```
frontend/  
  staging/  
    templates -> ../v3/  
    parameters.yaml  
  eastus/  
    templates -> ../v1/  
    parameters.yaml  
  westus/  
    templates -> ../v2/  
    parameters.yaml  
  ...
```

If you instead are using version control and tags, the filesystem would look like:

```
frontend/  
  staging-parameters.yaml  
  eastus-parameters.yaml  
  westus-parameters.yaml  
  templates/  
    frontend-deployment.yaml  
  ...
```

Using this structure, you would introduce a new tag for each region and use the file contents at that tag to deploy to that region.

Implementing Worldwide Deployment

Now that you have configurations for each region around the world, the question becomes one of how to update those various regions. One of the primary goals of using multiple regions is to ensure very high reliability and uptime. While it would be tempting to assume that cloud and data center outages are the primary causes of downtime, the truth is that outages are generally caused by new versions of software rolling out. Because of this, the key to a highly available system is limiting the effect or “blast radius” of any change that you might make. Thus, as you roll out a version across a variety of regions, it makes sense to move carefully from region to region in order to validate and gain confidence in one region before moving on to the next.

Rolling out software across the world generally looks more like a workflow than a single declarative update: you begin by updating the version in staging to the latest version and then proceed through all regions until it is rolled out everywhere. But how should you structure the various regions, and how long should you wait to validate between regions?

To determine the length of time between rollouts to regions, you want to consider the “mean time to smoke” for your software. This is the time it takes on average after a new release is rolled out to a region for a problem (if it exists) to be discovered. Obviously, each problem is unique and can take a varying amount of time to make itself known, and that is why you want to understand the *average* time. Managing software at scale is a business of probability, not certainty, so you want to wait for a time that makes the probability of an error low enough that you are comfortable moving on to the next region. Something like two to three times the mean time to smoke is probably a reasonable place to start, but it is highly variable depending on your application.

To determine the order of regions, it is important to consider the characteristics of various regions. For example, you are likely to have high-traffic regions and low-traffic regions. Depending on your application, you may have features that are more popular in one geographic area or another. All of these characteristics should be considered when putting together a release schedule. You likely want to begin by rolling out to a low-traffic region. This ensures that any early problems you catch are limited to an area of little impact. Though it is not a hard-and-fast rule, early problems are often the most severe, since they manifest quickly enough to be caught in the first region you roll out to. Thus, minimizing the impact of such problems on your customers makes sense. Next, you likely want to roll out to a high-traffic region. Once you have successfully validated that your release works correctly via the low-traffic region, you want to validate that it works correctly at scale. The only way to do this is to roll it out to a single high-traffic region. When you have successfully rolled out to

both a low- and a high-traffic region, you may have confidence that your application can safely roll out everywhere. However, if there are regional variations, you may want to also test more slowly across a variety of geographies before pushing your release more broadly.

When you put your release schedule together, it is important to follow it completely for every release, no matter how big or how small. Many outages have been caused by people accelerating releases either to fix some other problem, or because they believed it to be “safe.”

Dashboards and Monitoring for Worldwide Deployments

It may seem an odd concept when you are developing at a small scale, but one significant problem that you will likely run into at a medium or large scale is having different versions of your application deployed to different regions. This can happen for a variety of reasons (e.g., because a release has failed, been aborted, or had problems in a particular region), and if you don't track things carefully you can rapidly end up with an unmanageable snowflake of different versions deployed around the world. Furthermore, as customers inquire about fixes to bugs they are experiencing, a common question will become: “Is it deployed yet?”

Thus, it is essential to develop dashboards that can tell you at a glance what version is running in which region, as well as alerting that will fire when too many different versions of your application are deployed. A best practice is to limit the number of active versions to no more than three: one testing, one rolling out, and one being replaced by the rollout. Any more active versions than this is asking for trouble.

Summary

This chapter provides guidance on how to manage a Kubernetes application through software versions, deployment stages, and regions around the world. It highlights the principles that are the foundation of organizing your application: relying on the file-system for organization, using code review to ensure quality changes, and relying on feature flags or gates to make it easy to incrementally add and remove functionality.

As with everything, the recipes in this chapter should be taken as inspiration, rather than absolute truth. Read the guidance, and find the mix of approaches that works best for the particular circumstances of your application. But keep in mind that in laying out your application for deployment, you are setting a process that you will likely have to live with for a number of years.

Building a Raspberry Pi Kubernetes Cluster

While Kubernetes is often experienced through the virtual world of public cloud computing, where the closest you get to your cluster is a web browser or a terminal, it can be a very rewarding experience to physically build a Kubernetes cluster on bare metal. Likewise, nothing compares to physically pulling the power or network on a node and watching how Kubernetes reacts to heal your application to convince you of its utility.

Building your own cluster might seem like both a challenging and an expensive effort, but fortunately it is neither. The ability to purchase low-cost, system-on-chip computer boards, as well as a great deal of work by the community to make Kubernetes easier to install, means that it is possible to build a small Kubernetes cluster in a few hours.

In the following instructions, we focus on building a cluster of Raspberry Pi machines, but with slight adaptations the same instructions could be made to work with a variety of different single-board machines.

Parts List

The first thing you need to do is assemble the pieces for your cluster. In all of the examples here, we'll assume a four-node cluster. You could build a cluster of three nodes, or even a cluster of a hundred nodes if you wanted to, but four is a pretty good number.

To start, you'll need to purchase (or scrounge) the various pieces needed to build the cluster. Here is the shopping list, with some approximate prices as of the time of writing:

1. Four Raspberry Pi 3 boards (Raspberry Pi 2 will also work)—\$160
2. Four SDHC memory cards, at least 8 GB (buy high-quality ones!)—\$30–50
3. Four 12-inch Cat. 6 Ethernet cables—\$10
4. Four 12-inch USB A–Micro USB cables—\$10
5. One 5-port 10/100 Fast Ethernet switch—\$10
6. One 5-port USB charger—\$25
7. One Raspberry Pi stackable case capable of holding four Pis—\$40 (or build your own)
8. One USB-to-barrel plug for powering the Ethernet switch (optional)—\$5

The total for the cluster comes out to be about \$300, which you can drop down to \$200 by building a three-node cluster and skipping the case and the USB power cable for the switch (though the case and the cable really clean up the whole cluster).

One other note on memory cards: do not scrimp here. Low-end memory cards behave unpredictably and make your cluster really unstable. If you want to save some money, buy a smaller, high-quality card. High-quality 8 GB cards can be had for around \$7 each online.

Once you have your parts, you're ready to move on to building the cluster.



These instructions also assume that you have a device capable of flashing an SDHC card. If you do not, you will need to purchase a USB → memory card reader/writer.

Flashing Images

The default Raspbian image now supports Docker through the standard install methods, but to make things even easier, the Hypriot project provides images with Docker preinstalled.

Visit the [Hypriot downloads page](#) and download the latest stable image. Unzip the image, and you should now have an *.img* file. The Hypriot project also provides really excellent documentation for writing this image to your memory card for each of these platforms:

- [macOS](#)
- [Windows](#)
- [Linux](#)

Write the same image onto each of your memory cards.

First Boot: Master

The first thing to do is to boot just your master node. Assemble your cluster, and decide which is going to be the master node. Insert the memory card, plug the board into an HDMI output, and plug a keyboard into the USB port.

Next, attach the power to boot the board.

Log in at the prompt using the username `pi` and the password `hypr1ot`.



The very first thing you should do with your Raspberry Pi (or any new device) is to change the default password. The default password for every type of install everywhere is well known by people who will misbehave given a default login to a system. This makes the internet less safe for everyone. Please change your default passwords!

Setting Up Networking

The next step is to set up networking on the master.

First, set up WiFi. This is going to be the link between your cluster and the outside world. Edit the `/boot/user-data` file. Update the WiFi SSID and password to match your environment. If you ever want to switch networks, this is the file you need to edit. Once you have edited this, reboot with `sudo reboot` and validate that your networking is working.

The next step in networking is to set up a static IP address for your cluster's internal network. To do this, edit `/etc/network/interfaces.d/eth0` to read:

```
allow-hotplug eth0
iface eth0 inet static
    address 10.0.0.1
    netmask 255.255.255.0
    broadcast 10.0.0.255
    gateway 10.0.0.1
```

This sets the main Ethernet interface to have the statically allocated address 10.0.0.1.

Reboot the machine to claim the 10.0.0.1 address.

Next, we're going to install DHCP on this master so it will allocate addresses to the worker nodes. Run:

```
$ apt-get install isc-dhcp-server
```

Then configure the DHCP server as follows (`/etc/dhcp/dhcpd.conf`):

```

# Set a domain name, can basically be anything
option domain-name "cluster.home";

# Use Google DNS by default, you can substitute ISP-supplied values here
option domain-name-servers 8.8.8.8, 8.8.4.4;

# We'll use 10.0.0.X for our subnet
subnet 10.0.0.0 netmask 255.255.255.0 {
    range 10.0.0.1 10.0.0.10;
    option subnet-mask 255.255.255.0;
    option broadcast-address 10.0.0.255;
    option routers 10.0.0.1;
}
default-lease-time 600;
max-lease-time 7200;
authoritative;

```

You may also need to edit */etc/defaults/isc-dhcp-server* to set the INTERFACES environment variable to `eth0`.

Restart the DHCP server with `sudo systemctl restart isc-dhcp-server`.

Now your machine should be handing out IP addresses. You can test this by hooking up a second machine to the switch via Ethernet. This second machine should get the address 10.0.0.2 from the DHCP server.

Remember to edit the */etc/hostname* file to rename this machine to `node-1`.

The final step in setting up networking is setting up network address translation (NAT) so that your nodes can reach the public internet (if you want them to be able to do so).

Edit */etc/sysctl.conf* and set `net.ipv4.ip_forward=1` to turn on IP forwarding. You should then reboot the server for this to take effect. Alternately you can run `sudo sysctl net.ipv4.ip_forward=1` to make the change without rebooting. If you choose to do this you will still want to edit */etc/sysctl.conf* to make the setting permanent.

Then edit */etc/rc.local* (or the equivalent) and add `iptables` rules for forwarding from `eth0` to `wlan0` (and back):

```

iptables -t nat -A POSTROUTING -o wlan0 -j MASQUERADE
iptables -A FORWARD -i wlan0 -o eth0 -m state \
    --state RELATED,ESTABLISHED -j ACCEPT
iptables -A FORWARD -i eth0 -o wlan0 -j ACCEPT

```

At this point, the basic networking setup should be complete. Plug in and power up the remaining two boards (you should see them assigned the addresses 10.0.0.3 and 10.0.0.4). Edit the */etc/hostname* file on each machine to name them `node-2` and `node-3`, respectively.

Validate this by first looking at `/var/lib/dhcp/dhcpd.leases`, and then SSH to the nodes (remember again to change the default password first thing). Validate that the nodes can connect to the external internet.

Extra credit

There are a couple of extra steps you can take that will make it easier to manage your cluster.

The first is to edit `/etc/hosts` on each machine to map the names to the right addresses. On each machine, add:

```
...
10.0.0.1 kubernetes
10.0.0.2 node-1
10.0.0.3 node-2
10.0.0.4 node-3
...
```

Now you can use those names when connecting to those machines.

The second is to set up passwordless SSH access. To do this, run `ssh-keygen` and then copy the `$HOME/.ssh/id_rsa.pub` file into `/home/pirate/.ssh/authorized_keys` on `node-1`, `node-2`, and `node-3`.

Installing Kubernetes

At this point you should have all nodes up, with IP addresses and capable of accessing the internet. Now it's time to install Kubernetes on all of the nodes.

Using SSH, run the following commands on all nodes to install the `kubelet` and `kubeadm` tools. You will need to be root to execute these commands. Use `sudo su` to elevate to the root user.

First, add the encryption key for the packages:

```
# curl -s https://packages.cloud.google.com/apt/doc/apt-key.gpg | apt-key add -
```

Then add the repository to your list of repositories:

```
# echo "deb http://apt.kubernetes.io/ kubernetes-xenial main" \
>> /etc/apt/sources.list.d/kubernetes.list
```

Finally, update and install the Kubernetes tools. This will also update all packages on your system for good measure:

```
# apt-get update
$ apt-get upgrade
$ apt-get install -y kubelet kubeadm kubectl kubernetes-cni
```



Kubernetes uses a number of different kernel cgroups when it starts. It expects these capabilities to be present and can fail to start if they are not. Make sure that you are running the latest kernel available in the Raspberry Pi distribution.

Setting Up the Cluster

On the master node (the one running DHCP and connected to the internet), run:

```
$ sudo kubeadm init --pod-network-cidr 10.244.0.0/16 \  
  --apiserver-advertise-address 10.0.0.1 \  
  --apiserver-cert-extra-sans kubernetes.cluster.home
```

Note that you are advertising your internal-facing IP address, not your external address.

Eventually, this will print out a command for joining nodes to your cluster. It will look something like:

```
$ kubeadm join --token=<token> 10.0.0.1
```

SSH onto each of the worker nodes in your cluster and run that command.

When all of that is done, you should be able to run this command and see your working cluster:

```
$ kubectl get nodes
```

Setting up cluster networking

You have your node-level networking set up, but you need to set up the Pod-to-Pod networking. Since all of the nodes in your cluster are running on the same physical Ethernet network, you can simply set up the correct routing rules in the host kernels.

The easiest way to manage this is to use the **Flannel tool** created by CoreOS. Flannel supports a number of different routing modes; we will use the `host-gw` mode. You can download an example configuration from the [Flannel project page](#):

```
$ curl https://rawgit.com/coreos/flannel/master/Documentation/kube-flannel.yml \  
> kube-flannel.yaml
```

The default configuration that CoreOS supplies uses `vxlan` mode instead, and also uses the AMD64 architecture instead of ARM. To fix this, open up that configuration file in your favorite editor; replace `vxlan` with `host-gw` and replace all instances of `amd64` with `arm`.

You can also do this with the sed tool in place:

```
$ curl https://rawgit.com/coreos/flannel/master/Documentation/kube-flannel.yml \
  | sed "s/amd64/arm/g" | sed "s/vxlan/host-gw/g" \
  > kube-flannel.yaml
```

Once you have your updated *kube-flannel.yaml* file, you can create the Flannel networking setup with:

```
$ kubectl apply -f kube-flannel.yaml
```

This will create two objects, a ConfigMap used to configure Flannel and a DaemonSet that runs the actual Flannel daemon. You can inspect these with:

```
$ kubectl describe --namespace=kube-system configmaps/kube-flannel-cfg
$ kubectl describe --namespace=kube-system daemonsets/kube-flannel-ds
```

Setting up the GUI

Kubernetes ships with a rich GUI. You can install it by running:

```
$ DASHSRC=https://raw.githubusercontent.com/kubernetes/dashboard/master
$ curl -sSL \
  $DASHSRC/src/deploy/recommended/kubernetes-dashboard-arm-head.yaml \
  | kubectl apply -f -
```

To access this UI, you can run `kubectl proxy` and then point your browser to <http://localhost:8001/ui>, where *localhost* is local to the master node in your cluster. To view this from your laptop/desktop, you may need to set up an SSH tunnel to the root node using `ssh -L8001:localhost:8001 <master-ip-address>`.

Summary

At this point you should have a working Kubernetes cluster operating on your Raspberry Pis. This can be great for exploring Kubernetes. Schedule some jobs, open up the UI, and try breaking your cluster by rebooting machines or disconnecting the network.

A

- abstraction pattern, 205
- admin role, 171
- admission controllers, 196
 - built-in and custom, 196
 - creating SSL-based admission controller, 203
 - implementing to provide defaulting, 203
 - installing validating admission controller, 200
 - validating, 200
- AdmissionReview type, 203
- aggregating ClusterRoles, 173
- Ambassador Ingress controller, 100
- annotations, 65, 71-73
 - change-cause, 121
 - defining, 72
 - in deployment template for update, 119
 - kubectl annotate command, 40
 - kubernetes.io/created-by, 108
 - kubernetes.io/ingress.class, 97
 - uses of, 72
- APIs
 - decoupling servers via, 6
 - Kubernetes API server request flow, 196
 - Kubernetes API server, versions, 31
- application container images, 13
 - building with Docker, 16-20
 - image security, 19
 - optimizing image size, 18
 - using Dockerfiles, 16
 - multistage builds, 20
- application containers, 16
- application-oriented container APIs, benefits of, 9
- applications
 - easy scaling for, 6
 - organizing Kubernetes applications, 221-233
 - code review, 222
 - deploying your application worldwide, 230-233
 - feature flag gates and guards, 223
 - filesystem layout, 224
 - filesystems as source of truth, 222
 - guiding principles, 221
 - managing applications in source control, 224
 - managing releases, 225
 - parameterizing applications with templates, 229
 - structuring for development, testing, and deployment, 227-228
 - versioning with branches and tags, 225
 - versioning with directories, 226
 - real-world, deploying, 207-219
 - Ghost, 211-214
 - Jupyter, 207-209
 - Parse, 209-211
 - Redis, 214-219
 - in same and different Pods, 46
- authentication, 168
 - authentication providers supported by Kubernetes, 168
 - to container registries, 22
- authorization, 168
 - testing with can-i, 172

- autocompletion for commands and resources, 42
- autoscaling, 6
 - ReplicaSets, 110
 - based on CPU usage, 111
- availability, 1
- az CLI tool, installing, 28
- Azure Cloud Shell, 28
- Azure Kubernetes Service, installing Kubernetes with, 28

B

- base64 encoding, 162
- bash-completion package, 42
- branches, versioning with, 226
- build image, 21

C

- caching, using volumes for, 60
- cert-manager project, 99
- certificate signing request for Kubernetes API server, 203
- certificates
 - TLS, 99
 - creating secret to store, 158
 - webhook, 201
- cgroup technology (Linux kernel), 24
 - containers in Pods, 46
- change-cause annotation, 119, 121
- CLI (command-line interface)
 - Azure Cloud Shell, 28
 - deploying containers with Docker CLI, 23
 - Elastic Kubernetes Service and eksctl tool, 29
- clients
 - client-go library, informers, 199
 - rolling service updates and, 124
- cloud
 - container registries for different cloud providers, 22
 - DNS name for databases and other services, 180
 - infrastructure provided by, drawbacks of, 9
 - Ingress implementations by providers, 99
 - installing Kubernetes on public cloud provider, 28-29
 - Azure Kubernetes Service, 28
 - Google Kubernetes Engine (GKE), 28
 - Kubernetes services, 27

- Kubernetes-as-a-Service (KaaS) on public clouds, 8
- load-balancing capabilities by providers, 90
- LoadBalancer type, using, 81
- storage in, 178
- using DaemonSets to install software on nodes, 132
- volume types for providers, 182

- cloud-native applications, 1
- cluster IPs, 77
 - DNS address for, 77
 - environment variables, 85
 - kube-proxy and, 84
- cluster-admin permissions, 91
- cluster-admin role, 171
- ClusterRoleBindings, 170
 - built-in, 171
- ClusterRoles, 170
 - aggregating, 173
 - binding a group to, 174
 - built-in, 171
 - modifications of built-in roles, 171
- clusters
 - autoscaling, 111
 - cloud-native, 132
 - components, 34-36
 - Kubernetes DNS server, 34
 - Kubernetes proxy, 34
 - Kubernetes UI, 35
 - deploying, 27-31
 - installing Kubernetes locally, 29
 - installing Kubernetes on public cloud provider, 28-29
 - running Kubernetes in Docker, 30
 - running Kubernetes on Raspberry Pi, 31
 - easy scaling for, 6
 - exploring with kubectl, 31-34
 - checking cluster status, 31
 - listing worker nodes, 32
 - listing running Pods in, 49
 - MongoDB cluster creation, automating, 189-192
 - viewing with tools other than kubectl, 42
- CNAME records (DNS), 180
- code review for applications, 222
- command-line arguments, ConfigMap used for, 155, 156
- communication/synchronization, using volumes, 60

- compilers, 205
 - compute costs, forecasting with Kubernetes, 6
 - ConfigMaps, 153-157
 - creating, 153
 - creating for Ghost, 212
 - ghost-config-mysql, 213
 - creating for Redis installation, 216
 - data values, 162
 - managing, 162
 - creating ConfigMaps, 163
 - listing all ConfigMaps in a namespace, 162
 - updates, 163-165
 - viewing raw data, 163
 - MongoDB ConfigMap, 190
 - naming constraints, key names for data items, 161
 - using, 154
 - using to add script to MongoDB image, 190
 - configurations
 - container configuration file, 16
 - declarative configuration in Kubernetes, 4
 - declarative configuration in Pod manifests, 47
 - for deployments, 117
 - for rolling update, 125
 - Ghost application, 211
 - Ingress controller configuration, typical, 90
 - kubectl configuration file, 37
 - managing for load balancer, 90
 - parameterizing, 229
 - Redis installation, 215
 - consumers job, creating for a work queue, 149
 - container images, 14-16
 - cleaning up or removing, 24
 - Docker format, 15
 - making reusable, 153
 - multistage builds, 20
 - storing in remote registry, 22
 - updating, 119
 - Container Network Interface (CNI) plug-ins, 196
 - container registries, 14
 - (see also registries)
 - containers
 - and container APIs, benefits of, 2
 - application container images, 13
 - copying files to and from, 53
 - creating for Jupyter application, 208
 - decoupling application container image
 - from machines, 7
 - Docker runtime, 23
 - existing containers, adoption by ReplicaSets, 105
 - grouping in Pods, 46
 - criteria for, 47
 - immutable container images, 3
 - quarantining, 105
 - readiness checks, 55
 - resource requests per container, 57
 - restart policy for MongoDB container, 191
 - running in a Pod, information about, 51
 - system and application, 16
 - contexts, managing with kubectl, 37
 - Contour Ingress controller, installing, 91
 - configuring DNS, 92
 - configuring local hosts file, 92
 - controller-manager, 32
 - controllers for custom resources, 199
 - core-dns server, 35
 - cpu-shares functionality (Linux kernel), 58
 - CPUs
 - autoscaling based on usage, 111
 - capping usage with resource limits, 59
 - limiting usage with Docker, 24
 - resource requests for, 57
 - cron jobs
 - declaring a CronJob in Kubernetes, 150
 - setting up to run image garbage collector, 25
 - curl utility, using to communicate with work queue, 148
 - custom resources, 197
 - naming, 197
 - patterns for, 204-205
 - compilers, 205
 - just data, 204
 - operators, 205
 - validation and defaulting, 200
 - CustomResourceDefinition, 91, 197
 - example definition, 197
 - spec subobject, 197
- ## D
- DaemonSets, 34, 131-138
 - creating, 132-134
 - deleting, 137
 - limiting to specific nodes, 134-136
 - adding labels to nodes, 135

- using node selectors, 135
- scheduler, 132
- similarities with ReplicaSets, 131
- updating, 136
 - RollingUpdate strategy, 136
- dashboards
 - for worldwide application deployment, 233
 - Kubernetes UI, 35
- data items, specifying for ConfigMaps or secrets, 163
- debugging, kubectl commands for, 40-41, 52
- declarative configuration, 47
 - and undoing rollouts, 122
- declarative configuration objects, 4
- decoupled architectures, 5
 - DaemonSets and ReplicaSets in Kubernetes, 132
 - in Kubernetes, 104
- default-http-backend service, 95
- dependencies, 19
- deployment image, 21
- Deployment object, 72, 113
 - (see also deployments)
 - deleting only the Deployment object, 128
 - revision history attached to, 122
- deployments, 113-129
 - creating, 116
 - creating with kubectl run, 76
 - deleting, 128
 - deploying real-world applications, 207-219
 - Ghost, 211-214
 - Jupyter, 207-209
 - Parse, 209-211
 - Redis, 214-219
 - deploying your application around the world, 230-233
 - architectures for worldwide deployment, 230
 - dashboards and monitoring, 233
 - implementing worldwide deployment, 232
 - editing to add readiness check, 78
 - internal workings of, 114-115
 - Kubernetes deployment lifecycle, 128
 - managing, 117
 - monitoring, 128
 - strategies for, 123
 - Recreate strategy, 123
 - RollingUpdate strategy, 123-126
 - slowing rollouts to ensure service health, 126
 - updating, 118-123
 - container image, 119
 - rollout history, 120
 - scaling deployments, 118
- development teams, scaling with microservices, 7
- development, structuring your application for, 227
 - introducing a development tag, 228
- directories, versioning with, 226
- disk space on a node, getting information about, 33
- distributed systems, reliable and scalable, 1
- DNS
 - address for cluster IP, 77
 - configuring to external address for load balancer, 92
 - entries for MongoDB StatefulSet, 188
 - Kubernetes DNS server, 34
 - Kubernetes DNS service, 77
 - name resolution, limitations of, 75
 - names for external services, 179
- Docker, 14
 - building application images with, 16-20
 - CLI tool, deploying container with, 23
 - container runtime, 23
 - image format, 15
 - private registries, storing access credentials, 160
 - running Kubernetes in, 30
- Docker Desktop, Kubernetes installation with, 29
- Docker Hub, 22
- docker images command, 25
- docker login command, 22
- docker rmi command, 24
- docker run command
 - cpu-shares flag, 24
 - memory and --memory-swap flags, 24
 - publish, -d, and --name flags, 23
- docker system prune tool, 25
- Docker-in-Docker clusters, 27
- Dockerfiles, 17
 - for multistage application builds, 21
- .dockignore file, 17
- dynamic volume provisioning, 185

E

- Eclipse, 42
- edit role, 171
 - in ClusterRole aggregation, 173
- editors
 - editing a deployment in, 78
 - plug-ins for integration with Kubernetes, 42
- efficiency provided by Kubernetes, 10
- EKS (Elastic Kubernetes Service), 29
- eksctl command-line tool, 29
- elasticsearch tool, 53
- endpoints, 82
 - for default HTTP backend service, 95
 - for external services, 180
 - watch command on, 79
- environment variables
 - for cluster IPs, 85
 - for parse-server, 209
 - setting using ConfigMap, 155, 156
- Envoy load balancer, 91
- etcd server, 32
- events related to Pods, 50
 - getting information on, 51
 - killing a container, 55
- exec probes, 56
 - running commands in your container with, 53
- extending Kubernetes, 195-206
 - getting started, using Kubebuilder project library, 205
 - meaning of, 195
 - patterns for custom resources, 204-205
 - points of extensibility, 196-204
- ExternalName type, 179

F

- feature flag gates and guards, 223
- filesystems
 - ConfigMap defining small filesystem, 153, 154
 - layout for Kubernetes application, 224
 - layout for parameterization, 230
 - mounting host filesystem using volumes, 61
 - overlay, 15
 - source of truth for Kubernetes applications, 222
- fluentd tool, 53
 - creating fluentd logging agent on every node in target cluster, 132-134

- forecasting future compute costs, 6

G

- garbage collection, setting up for container images, 25
- gcloud tool, installing, 28
- Ghost, 211-214
 - configuring, 211
 - using MySQL for storage, 213
- GitHub
 - cert-manager on, 99
 - minikube on, 30
 - parse-server page, 211
- Gloo Ingress controller, 100
- Google Cloud Platform, 28
 - Google Container Registry, 22
- Google Kubernetes Engine (GKE), 28, 81
- grace period for Pod termination, 51
- graceful shutdown, 79
- groups, 168
 - identity and, 174
 - using for role bindings, 173

H

- headless services, 188
- health checks, 54-56
 - external services and, 181
 - for replicated Redis cluster, 214
 - liveness probes, 54
 - readiness probe, 55, 78, 127
 - tcpSocket and exec probes, 56
- heapster Pod, 110
- Helm, parameterizing configurations with, 229
- heptio-contour namespace, 91
- Horizontal Pod Autoscaling (HPA), 110
 - no direct link between ReplicaSets and, 111
- horizontal vs. vertical scaling, 111
- hostnames
 - Ingress and namespaces, 97
 - using with Ingress, 94
- hostPath volume, 61
- hosts
 - configuring local hosts file for Contour, 92
 - multiple paths on same host in Ingress system, 96
- HTTP health checks, 54, 79
- HTTP load balancing (see load balancing)
- HTTPS, webhook access via, 201
- hypervisors, 30

I

- identity in Kubernetes, 168
 - groups, 174
- image pull secrets, 161
- immutability
 - declarative configuration and, 4
 - value of, 3
- imperative vs. declarative configuration, 4, 47
- Informer pattern, 199
- infrastructure
 - abstracting, 9
 - as code, 4
 - immutable, 3, 132
- Ingress, 7, 89-101
 - advanced topics and gotchas, 96-99
 - Ingress and namespaces, 97
 - multiple Ingress objects, 97
 - path rewriting, 98
 - running multiple Ingress controllers, 97
 - servicing TLS, 98
 - alternate implementations, 99
 - installing Contour controller, 91
 - configuring DNS, 92
 - configuring local hosts file, 92
 - resource specification vs. controller implementation, 90
 - typical software Ingress controller configuration, 90
 - using, 92
 - hostnames, 94
 - paths, 95
 - simplest usage, 93
- IntelliJ, 42
- IP addresses
 - cluster IP, 77
 - external IP for Contour, 91
 - external services and, 179
 - for watched service endpoints, 82
 - hosting many HTTP sites on single address, 89
 - kube-proxy and cluster IPs, 84
 - unique, for services of type LoadBalancer, 92
- iptables rules, 84
- Istio project, 100

J

- jobs, 139-151
 - CronJob, 150

- Job object, 139
- patterns, 140-150
 - work queues, 146-150

JSON

- files representing Kubernetes objects, 39
 - work queue items, 148
- Jupyter, 207-209
- just data pattern, 204

K

- KaaS (Kubernetes-as-a-Service), 8
- kube-apiserver, --service-cluster-ip-range flag, 85
- kube-dns server, 35
- kube-proxy, 34, 86
 - cluster IPs and, 84
- kube-system namespace, 34, 95
 - listing Pods in, 110
- kubeadm, 27
- Kubebuilder project, library for Kubernetes API extensions, 205
- kubectl tool, 31-34
 - checking cluster status, 31
 - commands, 37-43
 - apply, 49, 91, 93, 107, 110
 - apply -f, 164
 - auth can-i, 172
 - auth reconcile, 172
 - autocompletion, 42
 - autoscale, 111
 - contexts, 37
 - cp, 53
 - create, 114
 - create configmap, 163
 - create secret, 159, 163
 - create secret docker-registry, 161
 - create secret generic, 164
 - create secret tls, 98
 - creating, updating, and destroying Kubernetes objects, 39
 - debugging, 40-41
 - delete, 48, 51, 111, 128, 137
 - describe, 50, 80, 93, 108, 117, 159
 - edit, 78, 80
 - edit configmap, 165
 - exec, 53
 - expose, 76
 - get, 48, 49, 68, 93
 - get clusterrolebindings, 171

- get clusterroles, 171
- get configmaps, 162
- get secrets, 162
- label, 68, 135
- labeling and annotating objects, 40
- logs, 52
- namespaces, 37
- port-forward, 52, 77
- replace --save-config, 117
- replace -f, 164, 164
- rolling-update, 114
- rollout, 118, 120, 137
- rollout history deployment, 120
- rollout pause deployments, 120
- rollout resume deployments, 120
- rollout undo deployments, 121
- run, 48
- scale, 109, 115
- viewing Kubernetes API objects, 38
- default-http-backend service, 95
- getting more information via command-line flags, 50
- installing, 29, 29
- listing worker nodes on a cluster, 32
- kubelet tool, 49
 - managing secrets volumes, 159
 - terminating containers for excess memory usage, 58
- Kubernetes objects, 38, 39
 - (see also objects (Kubernetes))
- kubernetes service, 76
- Kubernetes-as-a-Service (KaaS), 8
- kubernetes.io/created-by annotation, 108
- kubernetes.io/ingress.class annotation, 97

L

- labels, 65-71
 - adding to nodes, 135
 - applying, 67
 - Deployment object, 114
 - external services without label selectors, 179
 - for Kubernetes objects, using kubectl, 40
 - for Pods managed by a ReplicaSet, 108
 - for Pods, use by ReplicaSets, 107
 - in Kubernetes architecture, 71
 - key/value pairs, rules for, 66
 - modifying, 68
 - modifying on sick Pod, 105
 - motivations for using, 66

- node selectors, 135
- selectors, 68, 76
 - in API objects, 70
 - using in service discovery, 83
 - using to run DaemonSet Pods on specific nodes, 131
- “Let’s Encrypt” free certificate authority, 99
- libraries, external and shared, 13
- lifecycle stages, mapping to revisions, 228
- Linkerd project, 100
- live updates, 165
- liveness probes, 54
- load balancers
 - cloud-based, configuring with Ingress objects, 99
 - decoupling components via, 6
- load balancing, 7
 - for Kubernetes dashboard server, 35
 - for Kubernetes DNS server, 35
 - HTTP load balancing with Ingress, 89-101
 - alternate Ingress implementations, 99
 - Ingress spec vs. Ingress controllers, 90
 - installing Contour controller, 91-92
 - using Ingress, 92-96
- LoadBalancer type, 81, 89
- LoadTest custom resource, 198
 - creating, 199
 - validation, 200
- logging agent fluentd, creating on every node in target cluster, 132
- logical AND, 69
- login token for Jupyter application, 208
- logs
 - for Jupyter application container, 208
 - getting information on Pods from, 52
 - log aggregation services, 53
 - testing with auth can-i, 172

M

- machine/operating system (OS), decoupling
 - from application container, 8
- manifests (Pod), 47
 - adding volume to, 59
 - created by ReplicaSets, 106
 - creating, 48
 - declaring secrets volume, 160
 - using to delete a Pod, 51
- master and slave replicas, Redis installation, 215

- master nodes, 32
- maxSurge parameter (rolling updates), 126
- maxUnavailable parameter (rolling updates), 125, 137
- memory
 - capping usage with resource limits, 59
 - limiting usage for applications in container, 24
 - on a node, getting information about, 33
 - requests for, 58
- meta-resources, 197
- metadata
 - labels providing metadata for objects, 65
 - metadata section in Kubernetes objects,
 - annotation definitions in, 73
- metadata section (Pod manifests), 49
- microservices, 6
 - building with Kubernetes, advantages of, 7
 - represented by ReplicaSets, 105
- minikube, 27
 - minikube tunnel command, 91
 - using to install Kubernetes locally, 29
- minReadySeconds parameter
 - for DaemonSets, 137
 - for deployments, 127
- mobile application, accessing Kubernetes cluster from your phone, 42
- modularity in Kubernetes, 104
- MongoDB
 - cluster creation, automating, 189-192
 - manually replicated with StatefulSets, 187-189
 - readiness probes for Mongo-serving containers, 193
 - use of MongoDB cluster by Parse, 209
- multistage image builds, 20
- multitenant security, 167
- mutable vs. immutable infrastructure, 3
- MutatingWebhookConfiguration, 203
- MySQL databases
 - running a MySQL singleton, 181-185
 - using with Ghost application, 213

N

- namespaces, 7, 11
 - creating for Jupyter application, 207
 - default, changing with kubectl, 37
 - deployment of Kubernetes objects into, 178
 - heptio-contour, 91
 - in annotation keys, 72
 - in kubectl commands, 37
 - Ingress and, 97
- network traffic, restricting in a cluster, 71
- network-based storage, 61
- NetworkPolicy, 71
- NewReplicaSet, 118
- NFS persistent volume object, 182
- NGINX ingress controller, 100
- NodePorts, 80, 89
 - services type for installing Contour, 91
- nodes
 - limiting DaemonSets to specific nodes, 134-136
 - adding labels to nodes, 135
 - using node selectors, 135
 - listing worker nodes for Kubernetes cluster, 32
 - nodeName field in Pod specs, 132
 - resource use by, monitoring with kubectl, 41
 - “not my monkey, not my circus” line, 8

O

- objects (Kubernetes), 38
 - annotations, 71-73
 - creating, updating, and destroying, 39
 - labeling and annotating with kubectl, 40
 - labels providing metadata for, 65
 - selectors in, 70
- OldReplicaSets, 118
- OpenAPI, 200
- operations teams, decoupling of, 8
- operators
 - extensions using, 205
 - health detection and healing with, 5
- OSI model, 89
- overlay filesystems, 15

P

- Parse application, 209-211
 - building the parse-server, 209
 - deploying the parse-server, 209
 - prerequisites for, 209
 - testing, 210
- paths
 - in HTTP requests, using with Ingress, 95
 - Ingress and namespaces, 97
 - rewriting with Ingress controller, 98
- Pending state, 50

- persistent volume claim template, 193
- PersistentVolume, 10
- PersistentVolumeClaim, 10, 183
 - reclamation policy, and lifespan of persistent volumes, 186
 - referring to a storage class, 185
- PersistentVolumes, 51
- persisting data with volumes, 59-61
- Pods, 7, 45-63
 - accessing, 52
 - copying files to/from containers, 53
 - getting more information with logs, 52
 - running commands in container with exec, 53
 - using port forwarding, 52
 - ConfigMaps and, 153
 - created by ReplicaSet using Pod template, 106
 - creating via kubectl run command, 48
 - currently running in a cluster, listing and showing labels, 69
 - currently running on a node, getting information about, 33
 - DaemonSets determining which node Pods run on, 132
 - decoupling from DaemonSets, 132
 - deleting, 51
 - designing, question to ask, 46
 - example Pod with two containers and shared filesystem, 45
 - finding a ReplicaSet from, 108
 - finding set of Pods for a ReplicaSet, 108
 - getting details about, 50
 - health checks, 54-56
 - liveness probes, 54
 - other types of, 56
 - readiness probe, 55, 78, 127
 - Horizontal Pod Autoscaling (HPA), 110
 - imagePullSecrets spec field, 161
 - in Kubernetes, 46
 - managed by DaemonSets, deleting (or not), 137
 - managed by ReplicaSets
 - automatic rescheduling in failures, 103
 - deleting, 111, 128
 - manifests, 47
 - creating, 48
 - declaring secrets volume, 160
 - maximum number unavailable during rolling updates, 125, 137
 - node selectors in Pod spec when creating DaemonSets, 135
 - persisting data with volumes, 59-61
 - adding volumes to Pods, 59
 - using volumes for communication/synchronization, 60
 - Pod template in deployment specs, 117
 - relating Pods and ReplicaSets, 104
 - replicated sets of, 103
 - (see also ReplicaSets)
 - replicating a set of, reasons for, 131
 - resource management for, 56-59
 - capping usage with resource limits, 58
 - monitoring resource use with kubectl, 41
 - resource requests and minimum required resources, 56
 - running, 49
 - in parallel for consumers job, 149
 - listing running Pods in a cluster, 49
 - singleton Pod running MySQL, 184
 - updating in RollingUpdate strategy, 123
- port forwarding, 77
 - for updated deployment definition, 79
 - setting up for Jupyter container, 208
 - testing with auth can-i, 172
 - using to access a Pod, 52
 - using to connect to work queue daemon, 147
- port-forward command (kubectl), 41
- ports
 - in deployment definitions, 76
 - NodePort feature, 80
- private container registries, 22
 - storing access credentials for private Docker registries, 160
- process health checks, 54
 - (see also health checks)
- progressDeadlineSeconds parameter (deployments), 127, 129
- Progressing type, 129
- proxy (Kubernetes), 34
 - (see also kube-proxy)
- public container registries, 22

R

- Raspberry Pi
 - building a Kubernetes cluster, 235-241

- running Kubernetes on, 31
- RBAC (see role-based access control)
- rbac.authorization.kubernetes.io/autoupdate annotation, 171
- readiness probes, 55, 127
 - for Mongo-serving containers, 193
 - for services, 78
- reconciliation loops, 104, 132
- Recreate strategy, 123
- Redis, 214-219
 - configuring, 215
 - creating a Redis service, 216
 - deploying Redis cluster, 217
 - redis-sentinel, 214
 - redis-server, 214
 - testing our Redis cluster, 218
- registries (container), 14
 - private Docker registries, storing access credentials, 160
 - storing container images in remote registry, 22
- regular expressions
 - for key names in ConfigMap or secret key, 161
 - for path rewriting by Ingress controllers, 98
- releases, progression of, 227-228
 - development tag, 228
 - mapping stages to revisions, 228
- reliability, 1
- remote disks, persisting data with, 61
- replicas (StatefulSets), 187
- ReplicaSets, 48, 103-112
 - autoscaling
 - no direct link between HPA and ReplicaSets, 111
 - creating, 107
 - creating for MySQL singleton Pod, 183
 - creating to manage singleton work queue daemon, 146
 - deleting, 111
 - designing with, 105
 - for MongoDB, 189
 - inspecting, 108
 - finding a ReplicaSet from a Pod, 108
 - finding a set of Pods for a ReplicaSet, 108
 - managed by a deployment, 114
 - deleting, 128
 - fields pointing to, 118
 - old and new, managed by a deployment, 120
 - reconciliation loops, 104
 - relating Pods and ReplicaSets, 104
 - relationship between deployments and, 115
 - scaling, 109-111
 - autoscaling, 110
 - declarative scaling with kubectl apply, 109
 - imperative scaling with kubectl scale, 109
 - similarities with DaemonSets, 131
 - specification for, 106
 - labels, 107
 - Pod templates, 106
- resource management, 56-59
 - capping usage with resource limits, 58
 - resource requests and minimum required resources, 56
 - request limit details, 57
- resources
 - custom, 197
 - (see also custom resources)
 - external, connecting to Kubernetes services, 86
 - isolation with containers, 46
 - limiting applications' usage, 24
 - monitoring use of with kubectl top command, 41
- REST API, Kubernetes, 159
- restart policy for Pods, 55, 191
- revisionHistoryLimit property, 123
- revisions, 120
 - mapping to stages, 228
 - specifying revision of 0, 122
- Role object, 169
- role-based access control (RBAC), 167-175
 - advanced topics
 - aggregating ClusterRoles, 173
 - using groups for bindings, 173
 - general concept of roles and role bindings, 169
 - identity in Kubernetes, 168
 - multitenant security and, 167
 - roles and role bindings in Kubernetes, 169
 - auto-reconciliation of built-in roles, 171
 - using built-in roles, 171
 - verbs for Kubernetes roles, 170
 - techniques for managing, 172
 - managing in source control, 172

- testing authorization with can-i, 172
- RoleBinding object, 169
 - creating, 170
- rolling updates, 114
- RollingUpdate strategy, 123
 - configuring a rolling update, 125
 - managing multiple versions of your service, 124
 - using with DaemonSets, 136
- rollout commands for deployments, 118
- rollouts
 - current status of DaemonSet rollout, 137
 - history of, 120
 - and undoing a deployment, 122
 - monitoring, 120
 - pausing, 120
 - resuming, 120
 - slowing to ensure service health, 126
 - undoing last rollout, 121
- root path (/), 96

S

- scalability, 1
 - scaling your service and your teams, 5-9
 - decoupled architectures, 6
 - easy scaling for applications and clusters, 6
 - scaling development teams with micro-services, 7
 - separation of concerns for consistency and scaling, 8
- scaling
 - deployments, 115, 118
 - ReplicaSets, 109-111, 115
 - autoscaling, 110
 - declarative scaling with kubectl apply, 109
 - imperative scaling with kubectl scale, 109
- scheduler, 32
 - DaemonSets and, 132
 - placing Pods onto nodes, 48
- secrets, 158-161
 - consuming, 159
 - secrets volumes, 159
 - storing access credentials for private Docker registries, 160
 - creating, 158
 - data values, 162

- managing, 162
 - creating secrets, 163
 - listing all secrets in current namespace, 162
 - updates, 163-165
 - viewing raw data, 163
- naming constraints, key names for data items, 161
- specifying with TLS certificate and keys, 98
- security, 167
 - (see also authentication; role-based access control; secrets)
 - for application container images, 19
- selectors (label), 68, 76
 - filtering nodes based on labels, 135
 - finding Pods matching, 108
 - identifying ClusterRoles to be aggregated, 173
 - in API objects, 70
 - in ReplicaSet spec section, 107
 - in the Kubernetes architecture, 71
 - selector operators, 70
- self-healing systems, 5
- separation of concerns, 8
- service accounts, 168
- service discovery, 75-87
 - advanced details, 82-85
 - cluster IP environment variables, 85
 - endpoints, 82
 - kube-proxy and cluster IPs, 84
 - manual service discovery, 83
 - cloud integration, 81
 - connecting with other environments, 86
 - defined, 75
 - looking beyond the cluster, 79
 - readiness checks, 78
 - service DNS, 77
 - Service object, 76
- Service Meshes, 100
- Service object, 84
 - Endpoints object for, 82
 - operating at OSI level 4, 89
- services
 - backend, creating, 92
 - creating Redis service, 216
 - default-http-backend, 95
 - ensuring health by slowing rollouts, 126
 - exposing Ghost service, 213
 - exposing MySQL singleton as, 184

- hosting multiple services on paths of a single domain, 95
 - importing external storage services, 178-181
 - limitation, no health checking, 181
 - services without label selectors, 179
 - Ingress and namespaces, 97
 - Kubernetes, 7
 - managing multiple versions during rolling updates, 124
 - of type LoadBalancer, 90
 - (see also Ingress; LoadBalancer type)
 - queue service, creating, 147
 - stateless, ReplicaSets designed for, 106
 - shutdown, graceful, 79
 - singletons
 - running reliable singletons for storage, 181-186
 - dynamic volume provisioning, 185
 - software on a node, getting information about, 33
 - source control
 - managing RBAC in, 172
 - managing your application in, 224
 - storing declarative configuration in, 4
 - spec for CustomResourceDefinition, 197
 - spec for ReplicaSets, 106
 - spec section (Pod manifests), 49
 - spec.type field, 80, 81
 - spec.volume section (Pod manifest), 59
 - SSH tunneling, 80
 - state
 - DaemonSet management of, 132
 - desired state of a deployment, matching, 115
 - of all replicas managed by a ReplicaSet, 108
 - reconciliation loop approach to managing, 104
 - stateless services, 106
 - updating desired state of a deployment, 119
 - StatefulSets, 186-194
 - for Redis cluster, 217
 - manually replicated MongoDB with, 187-189
 - MongoDB cluster creation, automating, 189-192
 - persistent volumes and, 192
 - properties of, 187
 - Redis deployment, wrapper scripts for, 215
 - status.conditions array (deployments), 128
 - storage solutions, integrating with Kubernetes, 177-194
 - importing external services, 178-181
 - limitation, no health checking, 181
 - services without selectors, 179
 - MySQL database for Ghost storage, 213
 - native storage with StatefulSets, 186-194
 - manually replicated MongoDB, 187-189
 - persistent volumes and StatefulSets, 192
 - readiness probes for Mongo-serving containers, 193
 - running reliable singletons, 181-186
 - dynamic volume provisioning, 185
 - MySQL singleton, 181-185
 - StorageClass objects, 185
 - strategy object, 117
 - system containers, 16
 - system daemons, deploying, 131
 - (see also DaemonSets)
 - system:unauthenticated group, 168
 - cluster role allowing access to API server, 171
- ## T
- tab completion for commands and resources, 42
 - tags, source-control, 226
 - TCP, 89
 - tcpSocket health checks, 56
 - templates
 - annotation in template for deployment with
 - update information, 119
 - for ReplicaSets and Pods, 68
 - (see also deployments)
 - parameterizing applications with, 229
 - Pod template in deployment specs, 117
 - Terminating state, 51
 - testing
 - creating test environments with Kubernetes, 11
 - structuring your application for, 227
 - timing out a rollout, 127, 128
 - TLS key and certificate, creating secret to store, 158
 - TLS, serving in Ingress system, 98
 - tokens (login) for Jupyter application, 208
 - Traefik, 100

U

- UDP, 89
- UI (Kubernetes), 35
- undoing rollouts, 121
- update strategy, configuring for DaemonSets, 136
- updating ConfigMaps or secrets, 163
 - editing ConfigMap current version, 164
 - live updates, 165
 - recreate and update, 164
 - update from file, 164
- user accounts, 168
- UTF-8 text, ConfigMap data values, 162
- utilization, 56

V

- ValidatingWebhookConfiguration, 200
- validation, adding to custom resource, 200
- velocity in software development, 2
 - declarative configuration, 4
 - immutability, value of, 3
 - self-healing systems, 5
- versioning in Kubernetes, 31
 - managing periodic versions of applications, 225
 - using directories, 226
 - with branches and tags, 225
- vertical vs. horizontal scaling, 111
- view role, 171
- virtual hosting, 89
- virtualbox, 30
- Visual Studio Code, 42
- volume.beta.kubernetes.io/storage-class annotation, 186

- volumes, persisting data with, 59-61
 - ConfigMap volume, creating, 155
 - different ways to use volumes with Pods, 60
 - caching, 60
 - communication/synchronization, 60
 - dynamic volume provisioning, 185
 - mongo-init ConfigMap volume, 190
 - persistent volume for MySQL singleton, 182
 - persistent volumes and StatefulSets, 192
 - secrets volumes, 159
 - using volumes with Pods, 59

W

- watch command, 79, 208
- watches, 199
- webhooks
 - MutatingWebhookConfiguration, 203
 - ValidatingWebhookConfiguration, 200
- work queues, 146-150
 - creating the consumers job, 149
 - loading up, 148
 - starting, 146
- worker nodes, listing for Kubernetes cluster, 32

Y

- YAML
 - deployment.yaml file, 114, 116
 - files representing Kubernetes objects, 39
 - for ConfigMap object, 154
 - host-ingress.yaml file, 94
 - path-ingress.yaml file, 95
 - simple-ingress.yaml file, 93
 - tls-secret.yaml file, 98

About the Authors

Brendan Burns began his career with a brief stint in the software industry followed by a PhD in robotics focused on motion planning for human-like robot arms. This was followed by a brief stint as a professor of computer science. Eventually, he returned to Seattle and joined Google, where he worked on web search infrastructure with a special focus on low-latency indexing. While at Google, he created the Kubernetes project with Joe Beda and Craig McLuckie. Brendan is currently a director of engineering at Microsoft Azure.

Joe Beda started his career at Microsoft working on Internet Explorer (he was young and naive). Throughout 7 years at Microsoft and 10 at Google, Joe has worked on GUI frameworks, real-time voice and chat, telephony, machine learning for ads, and cloud computing. Most notably, while at Google, Joe started the Google Compute Engine and, along with Brendan Burns and Craig McLuckie, created Kubernetes. Along with Craig, Joe founded and sold a startup (Heptio) to VMware, where he is now a principal engineer. Joe proudly calls Seattle home.

Kelsey Hightower is a Principal Developer Advocate at Google working on Google's Cloud Platform. He has helped develop and refine many Google Cloud Products including Google's Kubernetes Engine, Cloud Functions, and Apigee's API Gateway. Kelsey spends most of his time with executives and developers spanning the global Fortune 1000, helping them understand and leverage Google technologies and platforms to grow their businesses. Kelsey is a huge open source contributor, maintaining projects that aid software developers and operations professionals in building and shipping cloud native applications. He is an accomplished author and keynote speaker, and was the inaugural winner of the CNCF Top Ambassador award for helping bootstrap the Kubernetes community. He is a mentor and technical advisor, helping founders turn their visions into reality.

Colophon

The animal on the cover of *Kubernetes: Up and Running* is an Atlantic white-sided dolphin (*Lagenorhynchus acutus*). As its name suggests, the white-sided dolphin has light patches on its sides and a light gray strip that runs from above the eye to below the dorsal fin. It is among the largest species of oceanic dolphins, and ranges throughout the North Atlantic Ocean. It prefers open water, so it is not often seen from the shore, but will readily approach boats and perform various acrobatic feats.

White-sided dolphins are social animals commonly found in large groups (known as pods) of about 60 individuals, though the size will vary depending on location and the availability of food. Dolphins often work as a team to harvest schools of fish, but they also hunt individually. They primarily search for prey using echolocation, which

is similar to sonar. The bulk of this marine mammal's diet consists of herring, mackerel, and squid.

The average lifespan of the white-sided dolphin is between 22–27 years. Females only mate every 2–3 years, and the gestation period is 11 months. Calves are typically born in June or July, and are weaned after 18 months. Dolphins have very great intelligence and display complex social behaviors like grieving, cooperation, and problem solving, due to their high brain-to-body ratio (the highest among aquatic mammals).

Many of the animals on O'Reilly covers are endangered; all of them are important to the world.

The cover illustration is by Karen Montgomery, based on a black and white engraving from *British Quadrupeds*. The cover fonts are Gilroy Semibold and Guardian Sans. The text font is Adobe Minion Pro; the heading font is Adobe Myriad Condensed; and the code font is Dalton Maag's Ubuntu Mono.